

SCD 3.81/06/180G 3.2SN BK BX

Weidmüller Interface GmbH & Co. KG

Klingenbergstraße 26

D-32758 Detmold

Germany

www.weidmueller.com

Product image

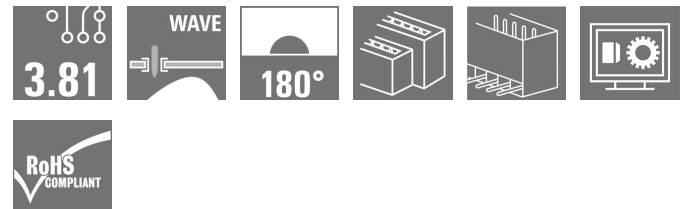

Similar to illustration

Two-tier SCD pin header for wave soldering.

- It allows you to use two interfaces on only one surface and with only one step in the work flow.
- Outlet direction: 180° (standing).
- Connections at the same level and with access that is flush over the front board.
- Space for labelling and coding
- Packed in cardboard box.

Weidmüller's 3.81-mm-pitch (0.15 inch) plug-in connectors are compatible with the layouts of standard connectors and offer space for labelling and coding.

General ordering data

Version	PCB plug-in connector, male header, closed side, THT solder connection, 3.81 mm, Number of poles: 6, 180°, Solder pin length (l): 3.2 mm, tinned, black, Box
Order No.	1030270000
Type	SCD 3.81/06/180G 3.2SN BK BX
GTIN (EAN)	4032248759446
Qty.	92 pc(s).
Product data	IEC: 320 V / 17.5 A UL: 300 V / 10 A
Packaging	Box

Creation date March 22, 2021 3:51:29 PM CET

SCD 3.81/06/180G 3.2SN BK BX

Weidmüller Interface GmbH & Co. KG

Klingenbergstraße 26

D-32758 Detmold

Germany

www.weidmueller.com

Technical data

Dimensions and weights

Depth	22.7 mm	Depth (inches)	0.894 inch
Height	25.1 mm	Height (inches)	0.988 inch
Height of lowest version	21.9 mm	Net weight	3.011 g
Width	12.82 mm	Width (inches)	0.505 inch

System specifications

Product family	OMNIMATE Signal - series BC/SC 3.81	Type of connection	Board connection
Mounting onto the PCB	THT solder connection	Pitch in mm (P)	3.81 mm
Pitch in inches (P)	0.15 inch	Outgoing elbow	180°
Number of poles	6	Number of solder pins per pole	1
Solder pin length (l)	3.2 mm	Solder pin length tolerance	+0,02 / -0.2 mm
Solder pin dimensions	d = 1.0 mm, Octagonal	Solder pin dimensions = d tolerance	0 / -0,03 mm
Solder eyelet hole diameter (D)	1.2 mm	Solder eyelet hole diameter tolerance (D)	+ 0,1 mm
L1 in mm	7.62 mm	L1 in inches	0.3 inch
Number of rows	2	Pin series quantity	2
Touch-safe protection acc. to DIN VDE 57 106	Safe from finger touch	Touch-safe protection acc. to DIN VDE 0470	IP 20
Volume resistance	≤5 mΩ	Can be coded	Yes
Plugging force/pole, max.	8 N	Pulling force/pole, max.	5.5 N

Material data

Insulating material	PA GF	Colour	black
Colour chart (similar)	RAL 9011	Insulating material group	II
Comparative Tracking Index (CTI)	≥ 550	UL 94 flammability rating	V-0
Contact material	Copper alloy	Contact surface	tinned
Storage temperature, min.	-40 °C	Storage temperature, max.	70 °C
Operating temperature, min.	-50 °C	Operating temperature, max.	120 °C
Temperature range, installation, min.	-25 °C	Temperature range, installation, max.	120 °C

Rated data acc. to IEC

tested acc. to standard	IEC 60664-1, IEC 61984	Rated current, min. number of poles (Tu=20°C)	17.5 A
Rated current, min. number of poles (Tu=40°C)	17 A	Rated voltage for surge voltage class / pollution degree II/2	320 V
Rated voltage for surge voltage class / pollution degree III/2	160 V	Rated voltage for surge voltage class / pollution degree III/3	160 V
Rated impulse voltage for surge voltage class/ pollution degree II/2	2.5 kV	Rated impulse voltage for surge voltage class/ pollution degree III/2	2.5 kV
Rated impulse voltage for surge voltage class/ contamination degree III/3	2.5 kV	Short-time withstand current resistance	3 x 1s with 76 A

Rated data acc. to CSA

Rated voltage (Use group B / CSA)	300 V	Rated current (Use group B / CSA)	11 A
-----------------------------------	-------	-----------------------------------	------

SCD 3.81/06/180G 3.2SN BK BX

Weidmüller Interface GmbH & Co. KG

Klingenbergstraße 26

D-32758 Detmold

Germany

www.weidmueller.com

Technical data

Rated data acc. to UL 1059

Institute (cURus)



Certificate No. (cURus)

E60693

Rated voltage (Use group B / UL 1059) 300 V

Rated voltage (Use group D / UL 1059) 300 V

Rated current (Use group B / UL 1059) 10 A

Rated current (Use group D / UL 1059) 10 A

Reference to approval values

Specifications are maximum values, details - see approval certificate.

Packing

Packaging	Box	VPE length	25 mm
VPE width	130 mm	VPE height	240 mm

Classifications

ETIM 6.0	EC002637	ETIM 7.0	EC002637
ECLASS 9.0	27-44-04-02	ECLASS 9.1	27-44-04-02
ECLASS 10.0	27-44-04-02	ECLASS 11.0	27-46-02-01

Important note

IPC conformity

Conformity: The products are developed, manufactured and delivered according international recognized standards and norms and comply with the assured properties in the data sheet resp. fulfill decorative properties in accordance with IPC-A-610 "Class 2". Further claims on the products can be evaluated on request.

Notes

- Additional colours on request
- Rated current related to rated cross-section & min. No. of poles.
- Rated data refer only to the component itself. Clearance and creepage distances to other components are to be designed in accordance with the relevant application standards.
- P on drawing = pitch
- Long term storage of the product with average temperature of 50 °C and average humidity 70%, 36 months

Approvals

Approvals



ROHS	Conform
UL File Number Search	E60693

Downloads

Approval/Certificate/Document of Conformity	Declaration of the Manufacturer
Engineering Data	STEP
Engineering Data	EPLAN, WSCAD
Product Change Notification	Change of packaging - DE Change of packaging - EN

Creation date March 22, 2021 3:51:29 PM CET

Catalogue status 12.03.2021 / We reserve the right to make technical changes.

3

SCD 3.81/06/180G 3.2SN BK BX

Weidmüller Interface GmbH & Co. KG
Klingenbergstraße 26
D-32758 Detmold
Germany

www.weidmueller.com

Dimensional drawing

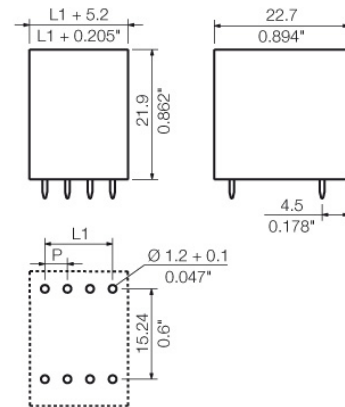

04

SCD 3.81/.../180G 3.2...

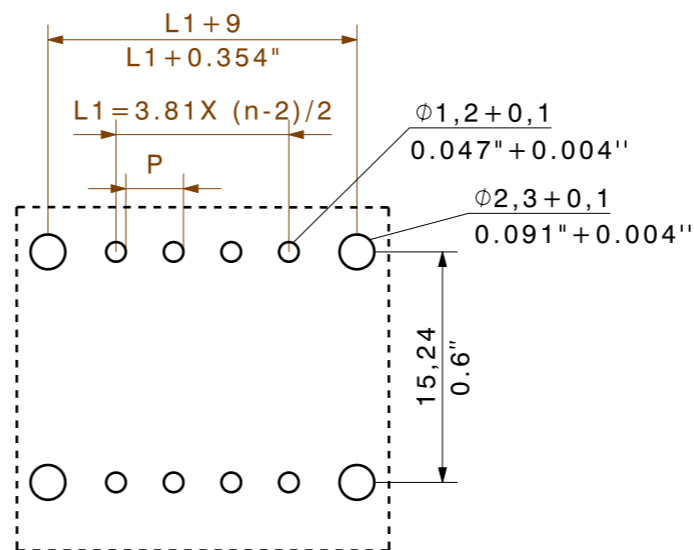
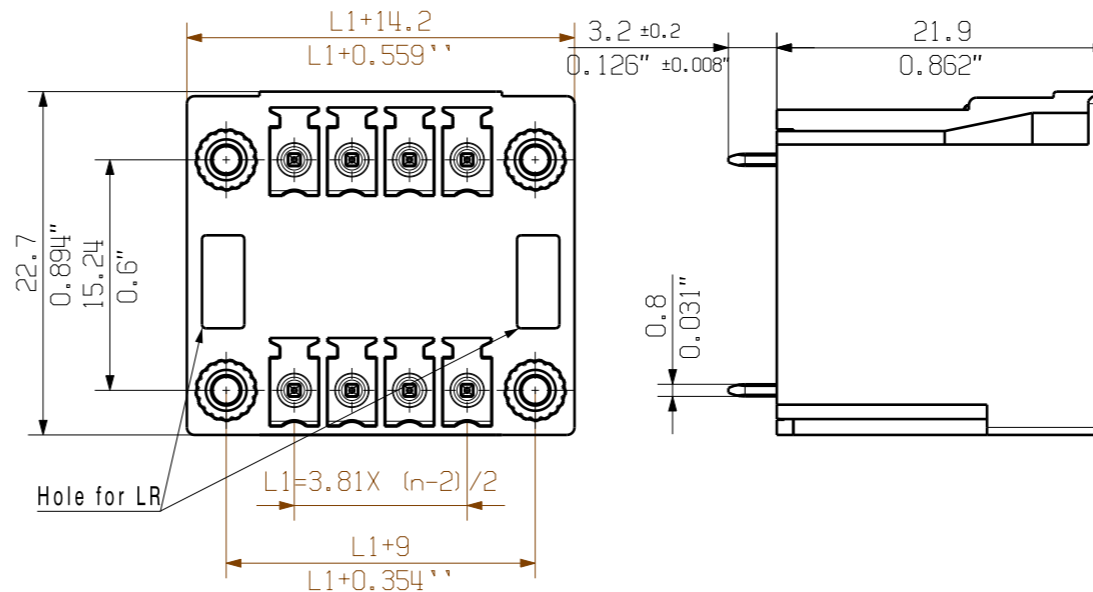
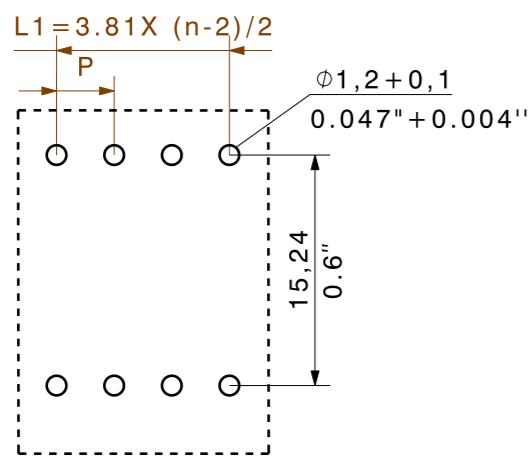
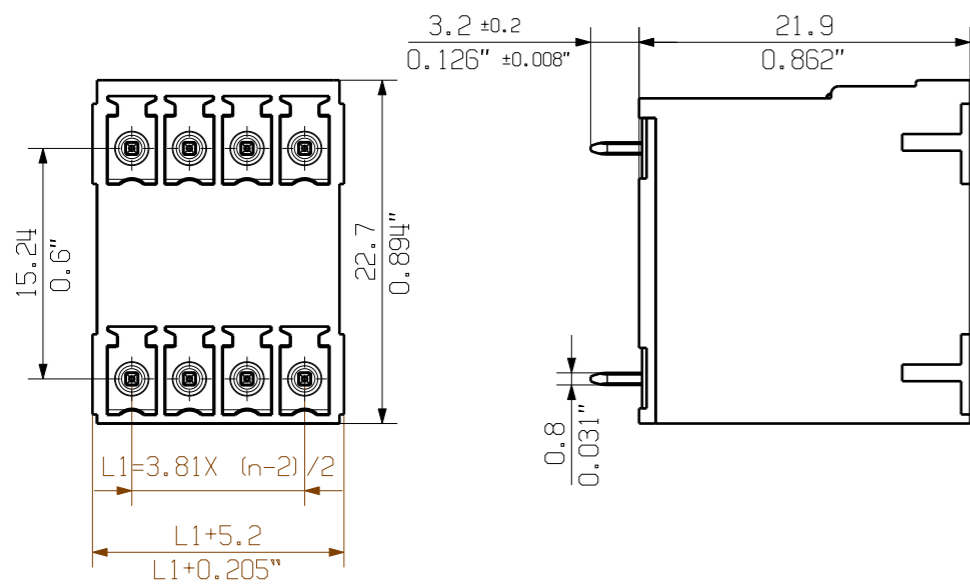

SCD 3.81/.../180F 3.2...
WITH
BCF 3.81/.../180 LR

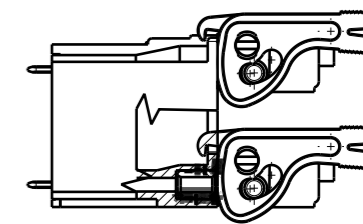

SCD 3.81/.../180F 3.2...
WITH
BCF 3.81/.../180 LR
M 1/1

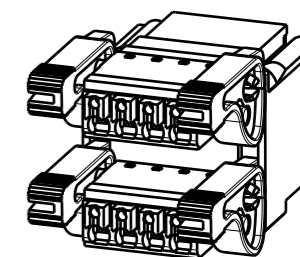

NOTE:

n=NO OF POLES
P=PITCH

KUNDENZEICHNUNG
CUSTOMER DRAWING

For the mounting of PCBs, it should be noted that the rated data stated here relates only to the PCB components alone.
The necessary creepage and clearance paths must be observed in connection with the respective applicant in accordance to IEC 664 / VDE 0110.
The current-carrying capacity and pitch tolerance is to be determined according to DIN IEC 326 part 3 very fine.

Weidmüller PCB components are tested to the DIN EN 61984 standard, and are valid for its field of application. Provided that the components are used to the intended purpose, all requirements with respect to the occurring of electrical, mechanical, thermic and corrosive stress will be satisfied.

16	57.15	2.250
15	53.34	2.100
14	49.53	1.950
13	45.72	1.800
12	41.91	1.650
11	38.10	1.500
10	34.29	1.350
9	30.48	1.200
8	26.67	1.050
7	22.86	0.900
6	19.05	0.750
5	15.24	0.600
4	11.43	0.450
3	7.62	0.300
2	3.81	0.150
n	L1 [mm]	L1 [inch]

GENERAL TOLERANCE: DIN ISO 2768-m		99958/4 06.03.18 MA_J		01		Cat.no.:	
RoHS COMPLIANT		Max. nos.		Modification		C 46286 04	
Scale: 5/1		Supersedes: .		Date		Name	
				08.01.2009		GE_G	
				14.03.2018		MA_J	
				XU_S		ZHOU_N	
				Weidmüller		Drawing no. Issue no.	
				Sheet 01 of 02 sheets		SCD... 3.81/.../180... THR-LOETANSCHLUSS STIFTLISTE THR SOLDER CONNECTION PIN HEADER	
				Product file: SCD 3.81		7079	

The reproduction, distribution and utilization of this document as well as the communication of its contents to others without explicit authorization is prohibited. Offenders will be held liable for the payment of damages. Weidmüller exclusively reserves the right to file for patents, utility models or designs.

© Weidmüller Interface GmbH & Co. KG

Recommended wave soldering profiles

Weidmüller Interface GmbH & Co. KG
 Klängenbergstraße 16
 D-32758 Detmold
 Germany
 Fon: +49 5231 14-0
 Fax: +49 5231 14-292083
 www.weidmueller.com

Single Wave:



Double Wave:



Wave soldering profiles

Wired connection elements should be processed in accordance with the DIN EN 61760-1 standard. We have included two recommendations for practical wave soldering profiles, with which Weidmüller PCB terminals and connectors are qualified.

When choosing a suitable profile for your application, the following factors also need to be considered:

- PCB thickness
- Proportion of Cu in the layers
- Single/double-sided assembly
- Product range
- Heating and cooling rates

The single and double wave profiles each indicate the recommended operating range, including the maximum soldering temperature of 260°C. In practice, the maximum soldering temperature is quite often well below the above maximum profile.