





CIRCUIT BREAKER 3VA2 IEC FRAME 400 BREAKING CAPACITY CLASS M ICU=55KA @ 415 V 3-POLE, MOTOR PROTECTION ETU860M, L SIG, IN=250A OVERLOAD PROTECTION IR=100A ...250A SHORT CIRCUIT PROTECTION ISD=1,2... 15 X IN, II=15 X IN NEUTRAL PROTECTION OPTIONAL WITH EXT. CT,UPTO 160% GROUND-FAULT, SWITCHABLE IG=0,2... 1 X IN, TG=0,05-0,8MS BUSBAR CONNECTION 2 AUXILIARY SWITCH



### Certificates

General Product Approval		EMC	Declaration of Conformity	Test Certificates
				
CCC	VDE		RCM	EG-Konf.
				<a href="#">sonstig</a>

### other

[Bestätigungen](#)      [sonstig](#)

### Further information

Information- and Downloadcenter (Catalogs, Brochures,...)

<http://www.siemens.com/lowvoltage/catalogs>

Industry Mall (Online ordering system)

<https://eb.automation.siemens.com/mall/en/WW/Catalog/Product/3VA2325-5MQ32-0AC0>

**Service&Support (Manuals, Certificates, Characteristics, FAQs,...)**

<http://support.automation.siemens.com/WW/view/en/3VA2325-5MQ32-0AC0/all>

**Image database (product images, 2D dimension drawings, 3D models, device circuit diagrams, ...)**

[http://www.automation.siemens.com/bilddb/cax\\_en.aspx?mlfb=3VA2325-5MQ32-0AC0](http://www.automation.siemens.com/bilddb/cax_en.aspx?mlfb=3VA2325-5MQ32-0AC0)

**CAX-Online-Generator**

<http://www.siemens.com/cax>

**Tender specifications**

<http://www.siemens.com/specifications>

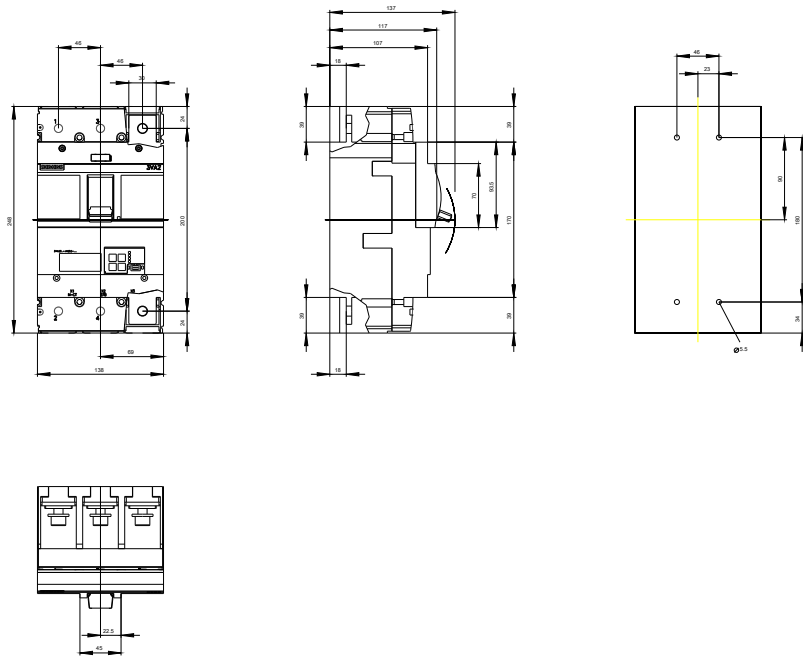

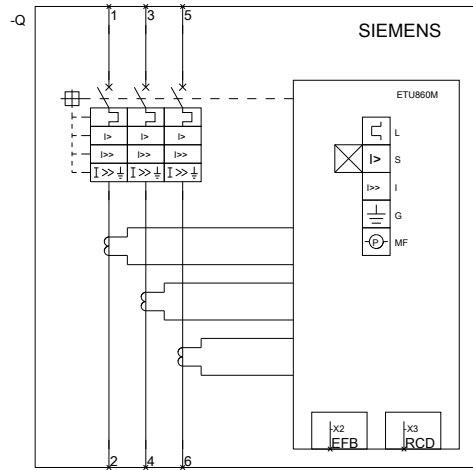

Siemens

3VA2xxx-xMQ3x-0AA0

Format / Size: Hybrid quer

last modified:

10/29/2016