



CIRCUIT BREAKER 3VA2 IEC FRAME 630 BREAKING CAPACITY CLASS H ICU=85KA @ 415 V 4-POLE, LINE PROTECTION ETU320, LI, IN=400A OVERLOAD PROTECTION IR=160A ...400A SHORT CIRCUIT PROTECTION II=1,5...12 X IN NEUTRAL PROTECTION ADJUSTABLE(OFF,50%,100%) BUSBAR CONNECTION

Model	
product brandname	SENTRON
Product designation	Molded case circuit breaker
Design of the product	Line protection
Type of load switch / according to UL 489 / Heating, Air Conditioning, and Refrigeration circuit breaker (HACR Type)	Yes
Design of the overcurrent release	ETU320
Protective function of the overcurrent release	LI
Number of poles	4
General technical data	
Tension assignée d'isolement Ui	800 V
Max. rated operational voltage Ue with AC 50/60Hz	690 V
Active power loss / for rated value of the current / at AC / in hot operating state / per device	63.3 W
Active power loss / for rated value of the current / at AC / in hot operating state / per pole	21.1 W
Mechanical service life (switching cycles) / typical	15 000

Electrical endurance (switching cycles) / at AC-1 / at 380/415 V 50/60 Hz	4 000
Neutral conductors / upgradeable/retrofitable	No
Ground fault monitoring version	Without
Product function	
• communication function	No
• other measurement function	No
Net weight	5.7 kg

### Electricity

Marking / according to UL 489 / 100%-rated breaker	No
Max. rated operational voltage of the size of the circuit-breaker	630 A
Courant permanent assigné Iu	400 A
Operating current	
• at 40 °C	400 A
• at 45 °C	400 A
• at 50 °C	400 A
• at 55 °C	388 A
• at 60 °C	380 A
• at 65 °C	368 A
• at 70 °C	352 A

### Switching capacity according to IEC 60947

Switching capacity class of the circuit breaker	H
Maximum short-circuit current breaking capacity (Icu)	
• at 240 V	110 kA
• at 415 V	85 kA
• at 690 V	6 kA
Operational short-circuit current breaking capacity (Ics)	
• at 240 V	110 kA
• at 415 V	85 kA
• at 690 V	6 kA
Short-circuit current making capacity (Icm)	
• at 240 V	242 kA
• at 415 V	187 kA
• at 690 V	9 kA

### Adjustable parameters

Adjustable response value current / I <sub>g</sub> min.	160 A
Adjustable response value current / I <sub>g</sub> min.	400 A
Adjustable response value current / I <sub>g</sub> min.	0.5
Adjustable response value current / I <sub>g</sub> min.	17

Short-term delayed / tripping switchable / I2t=ON/OFF	No
Adjustable response value current / li min.	600 A
Adjustable response value current / li max.	4 800 A
Design of the N-conductor protection	adjustable OFF; 50%; 100%
Ground fault protection / tripping switchable / I2t=ON/OFF	No

### Mechanical Design

Height [in]	9.8 in
Height	248 mm
Width [in]	7.2 in
Width	184 mm
Depth [in]	5.4 in
Depth	137 mm

### Connections

Arrangement of electrical connectors / for main current circuit	Front terminal
Type of electrical connection / for main current circuit	Lug terminal

### Auxiliary circuit

Number of CO contacts / for auxiliary contacts	0
------------------------------------------------	---

### Accessories





Product extension / optional / motor drive	Yes
--------------------------------------------	-----





### Environmental conditions

Protection class IP / on the front	IP40
Ambient temperature	
• during operation / minimum	-25 °C
• during operation / maximum	70 °C
• during storage / minimum	-40 °C
• during storage / maximum	80 °C

### Certificates

Equipment marking / acc. to DIN EN 81346-2	Q
Certificate of suitability / as approval for NAVAL (no combat vessels) / Supplement SB	No

General Product Approval			EMC	Declaration of Conformity	Test Certificates
 CCC	 VDE		 RCM	 EG-Konf.	<a href="#">Typprüfbescheinigung/Werkszeugnis</a>

Test Certificates	Shipping Approval				
<a href="#">sonstig</a>	 ABS	 BUREAU VERITAS	 GL	 LRS	 RMRS

other
<a href="#">sonstig</a>

#### Further information

##### Information- and Downloadcenter (Catalogs, Brochures,...)

<http://www.siemens.com/lowvoltage/catalogs>

##### Industry Mall (Online ordering system)

<https://eb.automation.siemens.com/mall/en/WW/Catalog/Product/3VA2440-6HL42-0AA0>

##### Service&Support (Manuals, Certificates, Characteristics, FAQs,...)

<http://support.automation.siemens.com/WW/view/en/3VA2440-6HL42-0AA0/all>

##### Image database (product images, 2D dimension drawings, 3D models, device circuit diagrams, ...)

[http://www.automation.siemens.com/bilddb/cax\\_en.aspx?mfb=3VA2440-6HL42-0AA0](http://www.automation.siemens.com/bilddb/cax_en.aspx?mfb=3VA2440-6HL42-0AA0)

##### CAX-Online-Generator

<http://www.siemens.com/cax>

##### Tender specifications

<http://www.siemens.com/specifications>

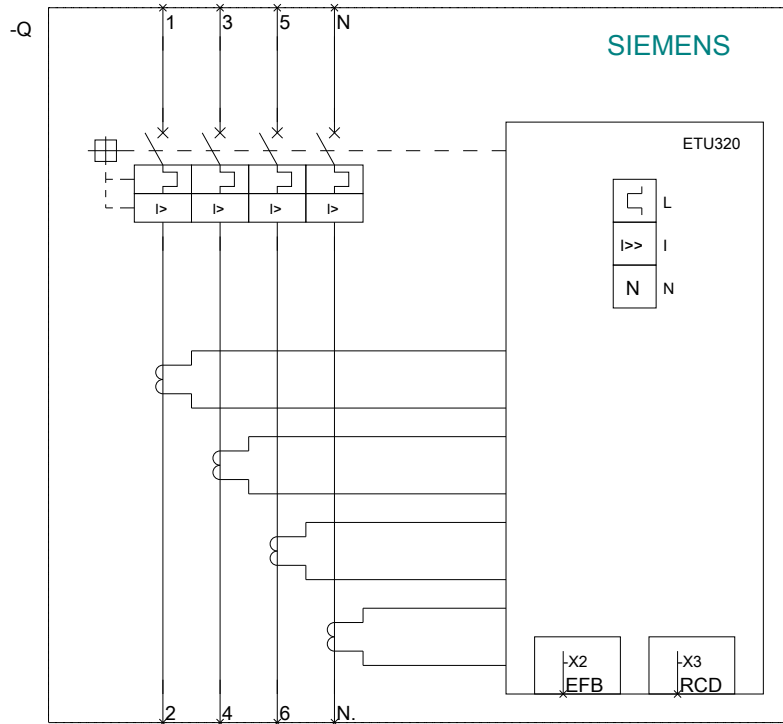
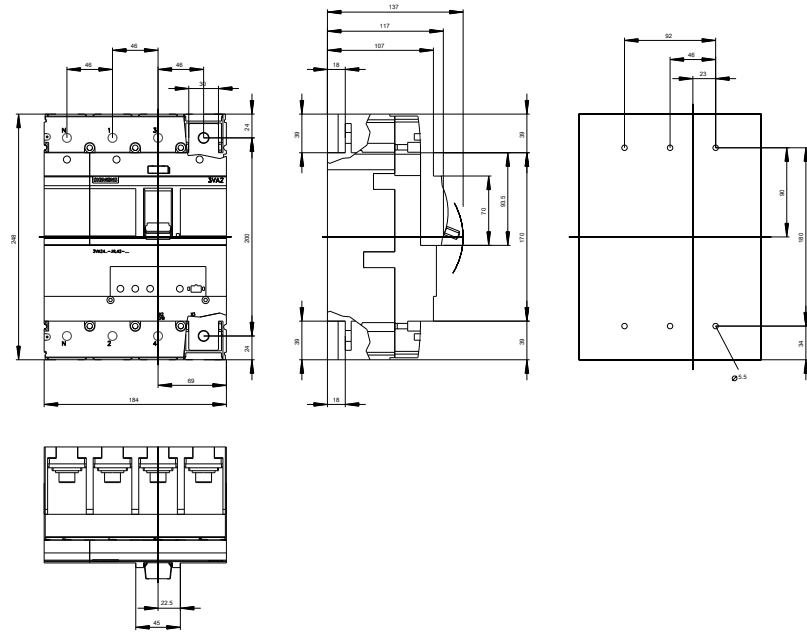

**last modified:**

10/29/2016