

CIRCUIT BREAKER 3VA2 IEC FRAME 630 BREAKING CAPACITY CLASS H ICU=85KA @ 415 V 3-POLE, LINE PROTECTION ETU320, LI, IN=630A OVERLOAD PROTECTION IR=252A ...630A SHORT CIRCUIT PROTECTION II=1,5... 9 X IN BUSBAR CONNECTION 2 AUXILIARY SWITCH HQ



| Model | |
|--|-----------------------------|
| product brandname | SENTRON |
| Product designation | Molded case circuit breaker |
| Design of the product | Line protection |
| Design of the overcurrent release | ETU320 |
| Protective function of the overcurrent release | LI |
| Number of poles | 3 |
| Design of the auxiliary release | Without auxiliary release |
| Design of the auxiliary switch | 2 auxiliary switches HQ |

| General technical data | |
|--|--------|
| Tension assignée d'isolement U_i | 800 V |
| Max. rated operational voltage U_e with AC 50/60Hz | 690 V |
| Active power loss / for rated value of the current / at AC / in hot operating state / per device | 162 W |
| Active power loss / for rated value of the current / at AC / in hot operating state / per pole | 54 W |
| Mechanical service life (switching cycles) / typical | 15 000 |
| Electrical endurance (switching cycles) / at AC-1 / at 380/415 V 50/60 Hz | 4 000 |

| | |
|---|---------|
| Neutral conductors / upgradeable/retrofitable | No |
| Ground fault monitoring version | Without |
| Product function | |
| • communication function | No |
| • Phase failure detection | No |
| • other measurement function | No |
| Net weight | 4.4 kg |

Electricity

| | |
|---|-------|
| Max. rated operational voltage of the size of the circuit-breaker | 630 A |
| Courant permanent assigné Iu | 630 A |
| Operating current | |
| • at 40 °C | 630 A |
| • at 45 °C | 612 A |
| • at 50 °C | 593 A |
| • at 55 °C | 575 A |
| • at 60 °C | 557 A |
| • at 65 °C | 538 A |
| • at 70 °C | 520 A |

Switching capacity according to IEC 60947

| | |
|---|--------|
| Switching capacity class of the circuit breaker | H |
| Maximum short-circuit current breaking capacity (Icu) | |
| • at 240 V | 110 kA |
| • at 415 V | 85 kA |
| • at 440 V | 85 kA |
| • at 500 V | 55 kA |
| • at 690 V | 20 kA |
| Operational short-circuit current breaking capacity (Ics) | |
| • at 240 V | 110 kA |
| • at 415 V | 85 kA |
| • at 440 V | 85 kA |
| • at 500 V | 55 kA |
| • at 690 V | 20 kA |
| Short-circuit current making capacity (Icm) | |
| • at 240 V | 242 kA |
| • at 415 V | 187 kA |
| • at 440 V | 187 kA |
| • at 500 V | 121 kA |
| • at 690 V | 40 kA |

Adjustable parameters

| | |
|--|---------|
| Adjustable response value current / I _g min. | 250 A |
| Adjustable response value current / I _g min. | 630 A |
| Adjustable response value current / I _g min. | 0.5 |
| Adjustable response value current / I _g min. | 12 |
| Short-term delayed / tripping switchable / I _{2t} =ON/OFF | No |
| Adjustable response value current / I _i min. | 945 A |
| Adjustable response value current / I _i max. | 5 670 A |

Mechanical Design

| | |
|--------|--------|
| Height | 248 mm |
| Width | 138 mm |
| Depth | 110 mm |

Connections

| | |
|---|----------------|
| Arrangement of electrical connectors / for main current circuit | Front terminal |
| Type of electrical connection / for main current circuit | Lug terminal |
| Type of connectable conductor cross-section, connection screw, width x thickness , min. | 20 x 1 |
| Type of connectable conductor cross-section, connection screw, width x thickness , max. | 35 x 10 |

Auxiliary circuit

| | |
|---|----|
| Product component | |
| <ul style="list-style-type: none"> • undervoltage release | No |
| <ul style="list-style-type: none"> • Voltage trigger | No |
| <ul style="list-style-type: none"> • undervoltage release with leading contact | No |
| <ul style="list-style-type: none"> • Trip indicator | No |
| Number of CO contacts / for auxiliary contacts | 2 |

Accessories





| | |
|---|------------------------------------|
| Product extension / optional / motor drive | Yes |
| Manufacturer's article number | |
| <ul style="list-style-type: none"> • of the supplied basic switch | 3VA2463-6HL32-0AA0 |
| <ul style="list-style-type: none"> • of the integrated auxiliary switch/alarm switch | 3VA9988-0AA12 |





Environmental conditions

| | |
|--|--------|
| Protection class IP / on the front | IP40 |
| Ambient temperature | |
| <ul style="list-style-type: none"> • during operation / minimum | -25 °C |
| <ul style="list-style-type: none"> • during operation / maximum | 70 °C |
| <ul style="list-style-type: none"> • during storage / minimum | -40 °C |
| <ul style="list-style-type: none"> • during storage / maximum | 80 °C |

Certificates

| | |
|--|---|
| Equipment marking / acc. to DIN EN 81346-2 | Q |
|--|---|

| | | | | | |
|--|--|---|--|---|---|
| General Product Approval | | | EMC | Declaration of Conformity | Test Certificates |
|  CCC |  VDE |  |  RCM |  EG-Konf. | Typprüfbescheinigung/Werkszeugnis |

| | | | | | |
|-------------------------|--|---|---|--|---|
| Test Certificates | Shipping Approval | | | | |
| sonstig |  ABS |  BUREAU VERITAS |  GL |  LRS |  RMRS |

| |
|-------------------------|
| other |
| sonstig |

Further information

Information- and Downloadcenter (Catalogs, Brochures,...)

<http://www.siemens.com/lowvoltage/catalogs>

Industry Mall (Online ordering system)

<https://eb.automation.siemens.com/mall/en/WW/Catalog/Product/3VA2463-6HL32-0AC0>

Service&Support (Manuals, Certificates, Characteristics, FAQs,...)

<http://support.automation.siemens.com/WW/view/en/3VA2463-6HL32-0AC0/all>

Image database (product images, 2D dimension drawings, 3D models, device circuit diagrams, ...)

http://www.automation.siemens.com/bilddb/cax_en.aspx?mfb=3VA2463-6HL32-0AC0

CAX-Online-Generator

<http://www.siemens.com/cax>

Tender specifications

<http://www.siemens.com/specifications>

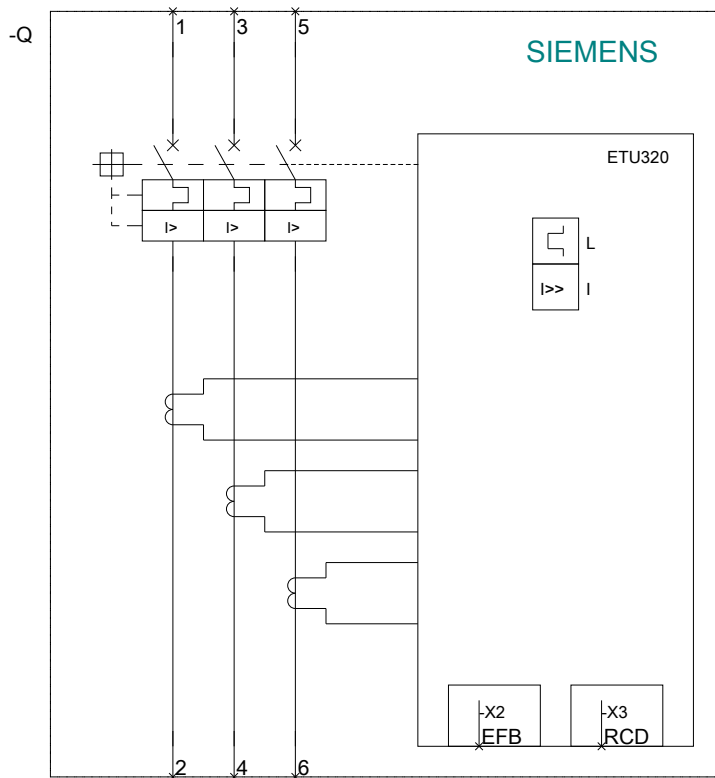
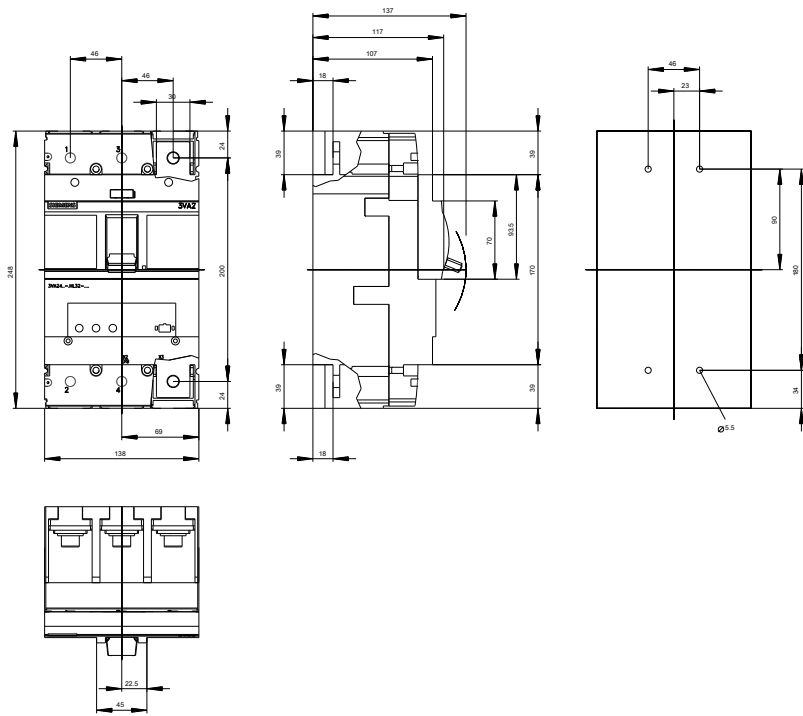

last modified:

10/29/2016