









CIRCUIT-BREAKER VL 250N WITHOUT ELECTRONIC TRIP UNIT STANDARD BREAKING CAPACITY ICU= 55KA / 415 V AC,
 3-POLE IN= < 250 A,
 RATED CURRENT WITH SCREWED UNION
 CONNECTION CONNECTIONS FOR CONTACT UNIT AND ELECTRONIC TRIP UNIT

Similar to image

General technical data:		
Number of poles		3
Electrical operating cycles as operating time / typical		10,000
Mechanical operating cycles as operating time / typical		20,000
Product component		
• auxiliary switch		No
• Voltage trigger		No
• undervoltage release mechanism		No
• undervoltage release with leading contact		No
Product function		
• ground-fault protection		No
• for zero conductors / short-circuit and overload protection		No
• overload protection		No
Operating cycles / maximum	1/s	120
Protection class IP		IP20
Impulse voltage resistance / rated value	kV	8
Ambient temperature		
• during operating	°C	-25 ... +70
• during storage	°C	-40 ... +80

Main circuit:		
Insulation voltage / for AC / rated value	V	800
Operating frequency		
• 1 / rated value	Hz	50
• 2 / rated value	Hz	60
Reference code		
• according to DIN 40719 extended according to IEC 204-2 / according to IEC 750		Q
• according to DIN EN 61346-2		Q
Operating voltage / for main circuit		
• at 50 Hz / with AC		
• maximum	V	690
• at 60 Hz / with AC		
• maximum	V	690
Operating current		
• at 40 °C / rated value	A	250
• at 50 °C / rated value	A	250
• at 60 °C / rated value	A	232.5
• at 70 °C / rated value	A	215
Continuous current / rated value	A	250
Derating temperature / for the rated value of the continuous current	°C	50
• acc. to UL 489	°C	40
Auxiliary circuit:		
Number of NC contacts / for auxiliary contacts		0
Number of NO contacts / for auxiliary contacts		0
Short-circuit:		
Breaking capacity limit short-circuit current (I_{cu}) / at 415 V / rated value	kA	55
Installation/mounting/dimensions:		
Mounting type		fixed mounting
Height	mm	185.5
Width	mm	104.5
Depth	mm	106.5
Connections:		
Arrangement of electrical connectors / for main current circuit		front side
Design of the electrical connection / for main current circuit		screw-type terminals
Certificates/approvals:		

General Product Approval		Declaration of Conformity	Test Certificates		
 CCC	TSE	 EG-Konf.	Special Test Certificate		
Shipping Approval					
 ABS	 BUREAU VERITAS	 DNV	 GL	 PRS	 RINA
Shipping Approval	other				
 RMRS	Confirmation	other	Environmental Confirmations		

Further information:

Information- and Downloadcenter (Catalogs, Brochures,...)

<http://www.siemens.com/lowvoltage/catalogs>

Industry Mall (Online ordering system)

<https://eb.automation.siemens.com/mall/en/WW/Catalog/Product/3VL3725-1AA36-0AA0>

Service&Support (Manuals, Certificates, Characteristics, FAQs,...)

<http://support.automation.siemens.com/WWW/view/en/3VL3725-1AA36-0AA0/all>

Image database (product images, 2D dimension drawings, 3D models, device circuit diagrams, ...)

http://www.automation.siemens.com/bilddb/cax_en.aspx?mlfb=3VL3725-1AA36-0AA0

CAX-Online-Generator

<http://www.siemens.com/cax>

Tender specifications

[Datanorm GAEB81](#) [GAEB83](#) [RTF](#) [TXT](#)

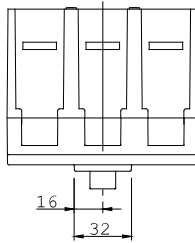
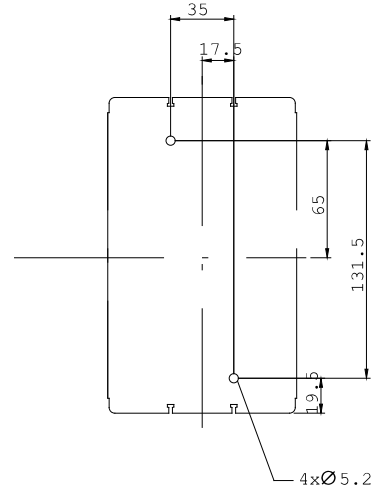
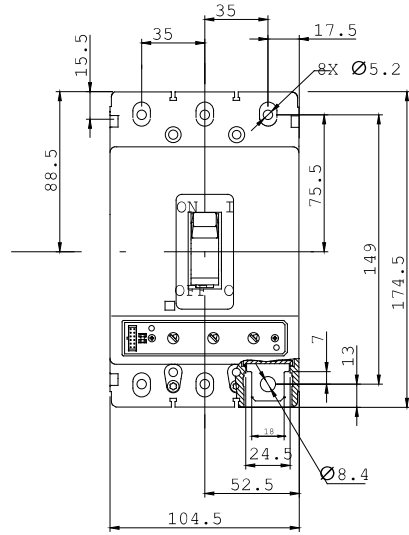
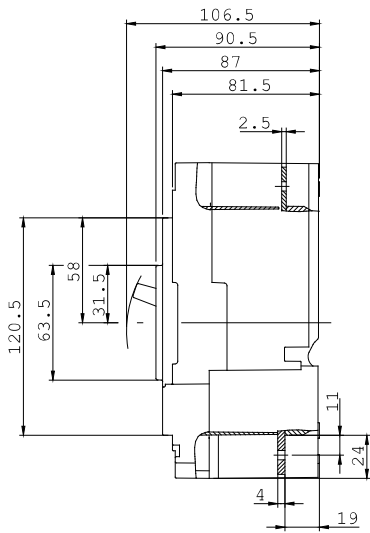

last change:

Jun 16, 2014