

DISCONNECTOR, 92MM 100A 3POLE RED/YELLOW





Similar to image

Technical data:

Number of poles		3
Design of the operating mechanism		selector switch
Product equipment / interlock		No
Continuous current / rated value	A	100
Acceptability for application / emergency stop switch		Yes
Type from device		other
Design of the electrical connection / for main current circuit		screw-type terminals
Number of NC contacts / for auxiliary contacts		0
Acceptability for application / safety cut-out switch		No
Type of the driving mechanism / motor drive		No
Number of NO contacts / for auxiliary contacts		3
Number of change-over switches / for auxiliary contacts		0
Operating voltage / at 50/60 Hz / for AC / rated value	V	690
Service power / at AC 23 A / at 400 V / at 50/60 Hz / rated value	kW	44
Protection class IP		IP20
Acceptability for application / main switch		No
Acceptability for application / switch disconnecter		Yes
Product extension / optional / motor drive		No

Product extension / optional / voltage trigger	No
Type of fixing / 4-hole front mounting	No
Type of fixing / central front mounting	No
Suitability for integration / distribution board	Yes
Acceptability for application / maintenance/repair switch	Yes

Certificates/approvals:

General Product Approval	Declaration of Conformity	other
 GOST	 KEMA	 EG-Konf.
		Environmental Confirmations

Further information:

Information- and Downloadcenter (Catalogs, Brochures,...)

<http://www.siemens.com/lowvoltage/catalogs>

Industry Mall (Online ordering system)

<http://www.siemens.com/lowvoltage/mall>

Service&Support (Manuals, Certificates, Characteristics, FAQs,...)

<http://support.automation.siemens.com/WW/view/en/5TE1315/all>

Image database (product images, 2D dimension drawings, 3D models, device circuit diagrams, ...)

http://www.automation.siemens.com/bilddb/cax_en.aspx?mlfb=5TE1315

CAX-Online-Generator

<http://www.siemens.com/cax>

Tender specifications

[Datanorm GAEB81](#) [GAEB83](#) [RTF](#) [TXT](#)

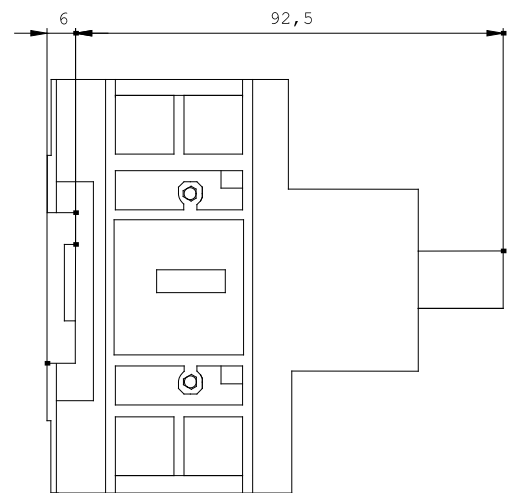
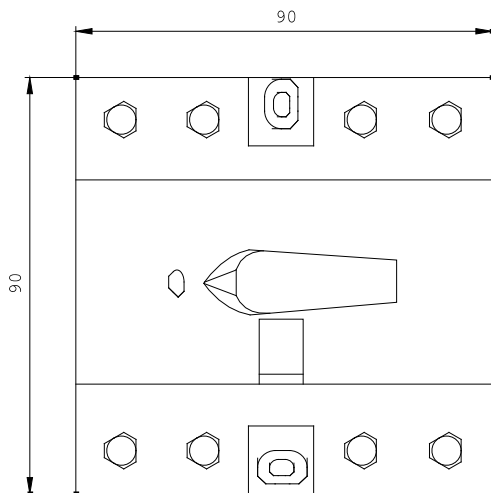

last change:

Nov 5, 2012