



## Main

Range compatibility	Lexium 23 Plus
Product or component type	Servo motor
Device short name	BCH

## Complementary

Maximum mechanical speed	3000 rpm
[Us] rated supply voltage	220 V
Network number of phases	Single phase
Continuous stall current	8.3 A
Continuous power	1.5 kW
Shaft end	Smooth shaft
Second shaft	Without second shaft end
Shaft diameter	22 mm
Shaft length	47 mm
Feedback type	20 bits incremental encoder
Holding brake	With
Holding torque	10 N.m
Mounting support	Asian standard flange
Motor flange size	130 mm
Torque constant	0.87 N.m/A
Back emf constant	31.8 V/krpm at 20 °C
Rotor inertia	11.9 kg.cm <sup>2</sup>
Stator resistance	0.52 Ohm at 20 °C
Stator inductance	8.02 mH at 20 °C
Stator electrical time constant	15.31 ms at 20 °C
Maximum radial force Fr	490 N
Maximum axial force Fa	98 N
Brake pull-in power	19 W
Type of cooling	Natural convection
Length	202 mm
Number of motor stacks	3

Disclaimer: This documentation is not intended as a substitute for and is not to be used for determining suitability or reliability of these products for specific user applications

Centring collar diameter	110 mm
Centring collar depth	6 mm
Number of mounting holes	4
Mounting holes diameter	9 mm
Circle diameter of the mounting holes	145 mm
Distance shaft shoulder-flange	47 mm
Product weight	8.9 kg

## Environment

IP degree of protection	IP65
Ambient air temperature for operation	0...40 °C

## Contractual warranty

Warranty	18 months
----------	-----------

Dimensions

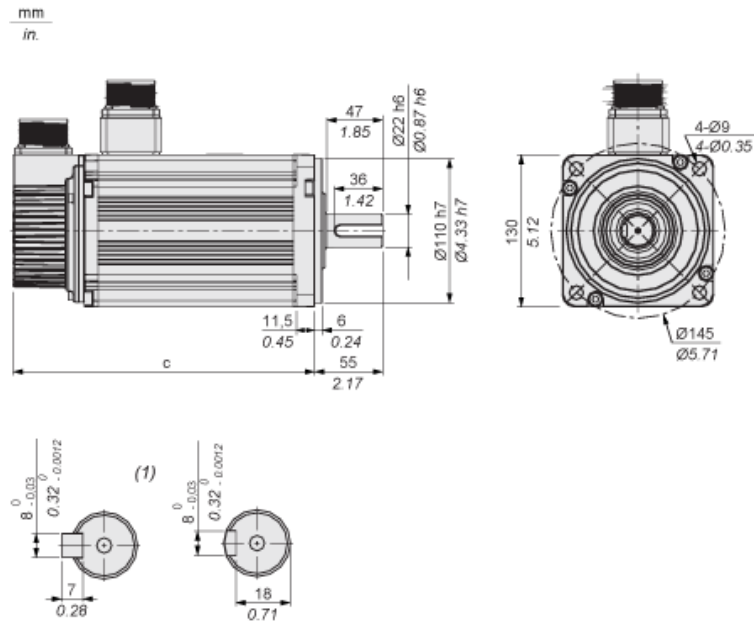

(1) Shaft end, keyed slot (optional)

Dimensions in mm

c (without holding brake)	c (with holding brake)
167.5	202

Dimensions in in.

c (without holding brake)	c (with holding brake)
6.59	7.95

Torque/Speed Curves with 220 V Single Phase Supply Voltage

Servo Motor with LXM23-U15M3X Servo Drive

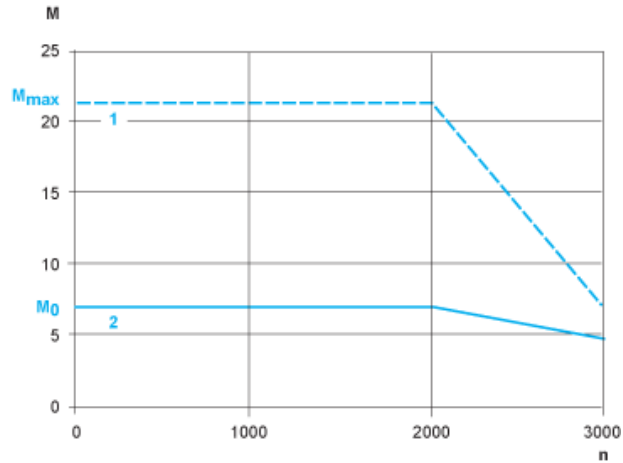

- M : Torque in Nm
- n : Speed in rpm
- 1 : Peak torque
- 2 : Continuous torque