

E43005

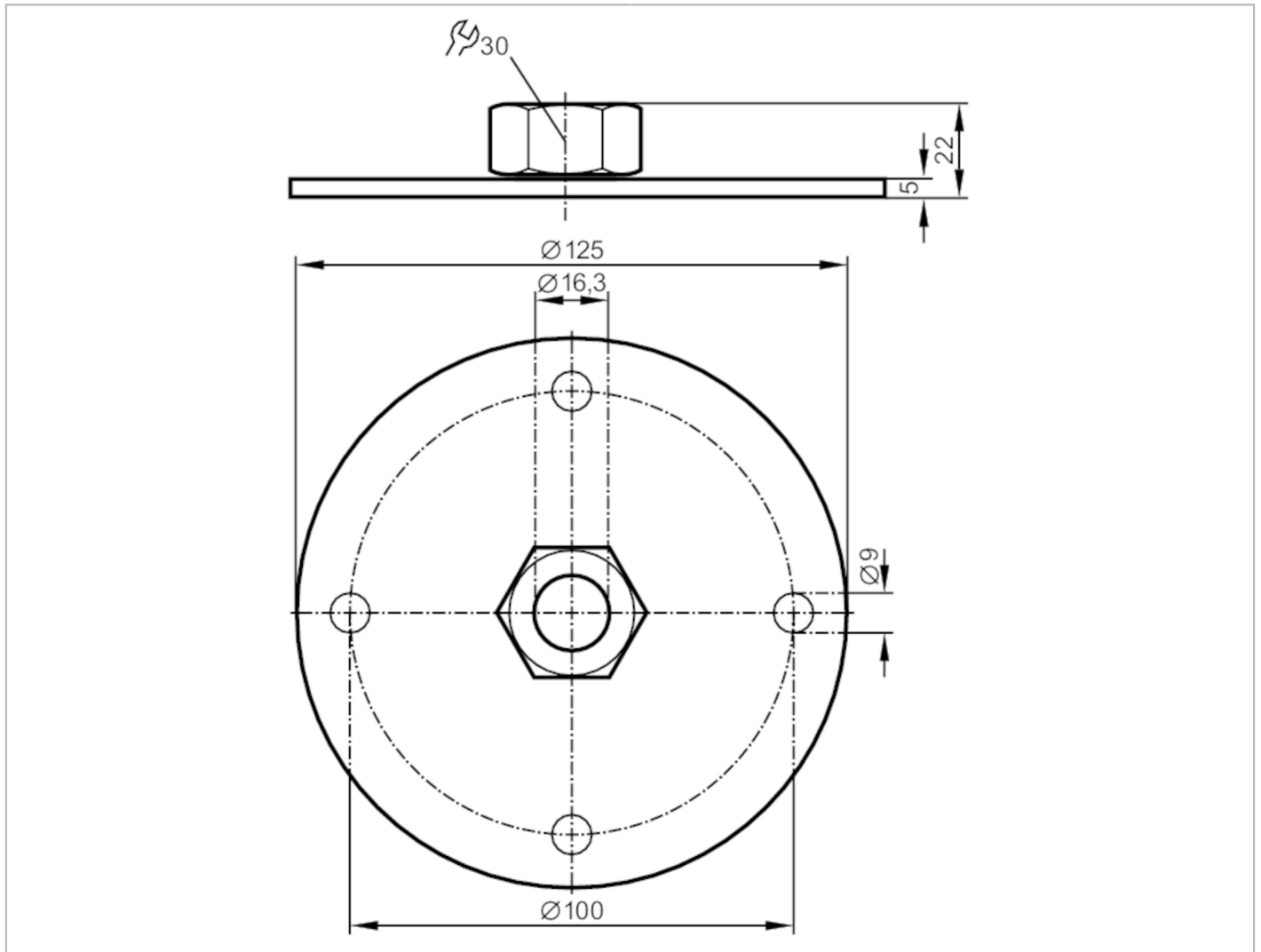

Flange plate for level sensors

FLANGE PLATE 100-125 D16



Application	
Design	for capacitive level sensors LK, LI, LT, LL
Pressure rating [bar]	0.5
Operating conditions	
Ambient temperature [°C]	0...80
Mechanical data	
Weight [g]	251
Materials	flange: aluminium anodised; Lock nut: stainless steel; spacer: brass; clamping ring: FKM
Tightening torque [Nm]	6...9
Remarks	
Pack quantity	1 pcs.