

# EBC032

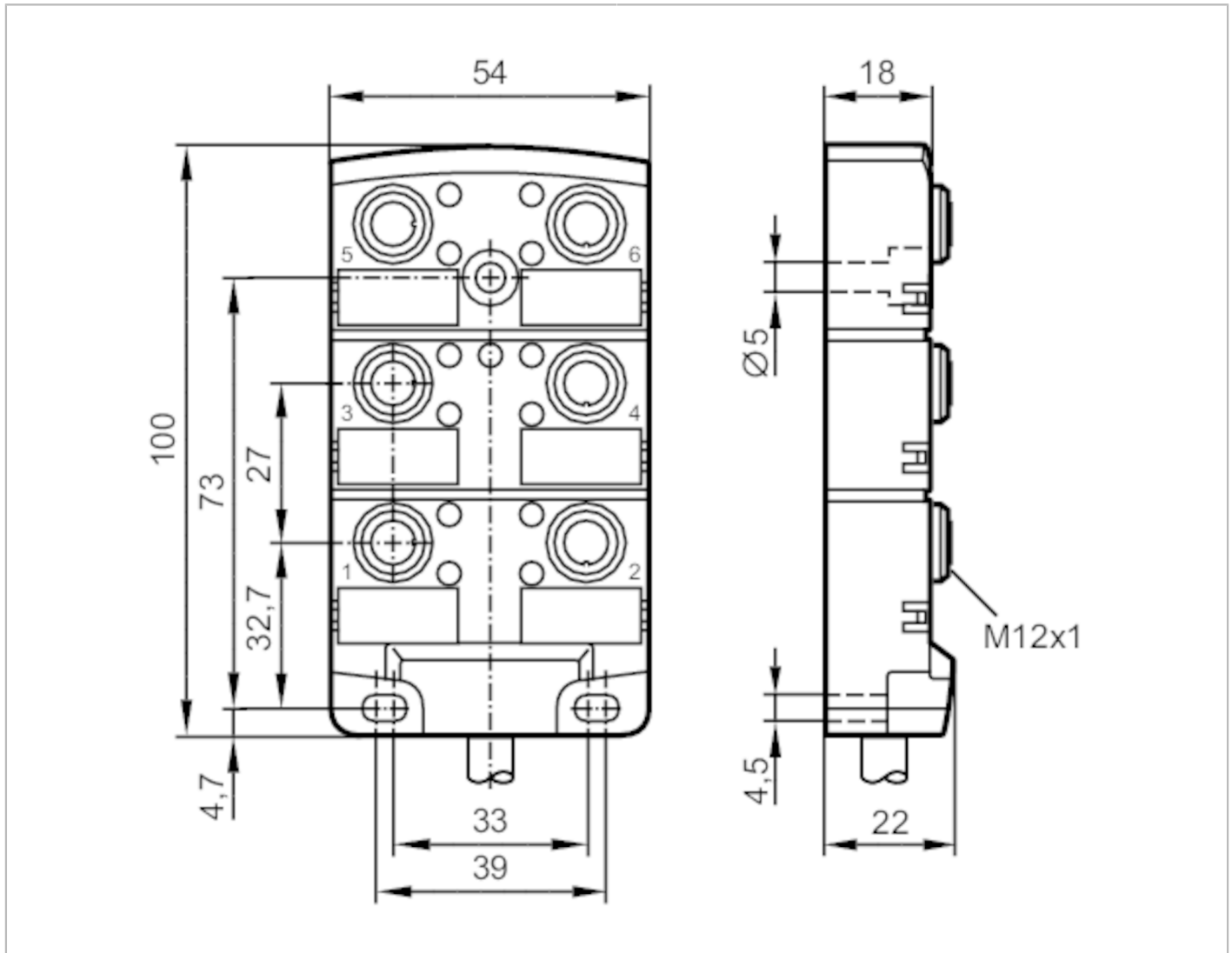

## Splitter box

ZDO6H05DMSS0010H15



### Application

Free from silicone yes

### Electrical data

Operating voltage [V] 10...30 DC; ("supply class 2" to cULus)

Protection class II

Max. current load per module/slot [A] 4

Max. current load total [A] 12

### Outputs

Electrical design PNP

### Operating conditions

Ambient temperature [°C] -25...80

Ambient temperature (moving) [°C] -5...60

Protection IP 67; IP 68; ("enclosure type 1" according to cULus)

# EBC032



## Splitter box

ZDO6H05DMSS0010H15

Mechanical data		
Weight	[g]	1373.2
Dimensions	[mm]	22 x 54 x 100
Materials		PA
Number of ports splitter box		6
Connector type		M12
Drag chain suitability	bending radius for flexible use	min. 10 x cable diameter
	bending cycles	> 2 Mio.
Displays / operating elements		
Display	switching status	12 x LED, yellow
	operation	1 x LED, green
Accessories		
Accessories (supplied)		Protective caps: 2 labels: 6
Remarks		
Pack quantity		1 pcs.
Electrical connection		
Cable: 10 m, PUR, Halogen-free, black, Ø 8.8 mm; 12 x 0.34 mm <sup>2</sup> (63 x Ø 0.1 mm) + 3 x 1.0 mm <sup>2</sup> (127 x Ø 0.1 mm)		
Electrical connection - slot		
Connector: 6 x M12; Moulded body: PA; Contacts: gold-plated; Tightening torque: 0.8...1.5 Nm		



## Splitter box

ZDO6H05DMSS0010H15

### Connection

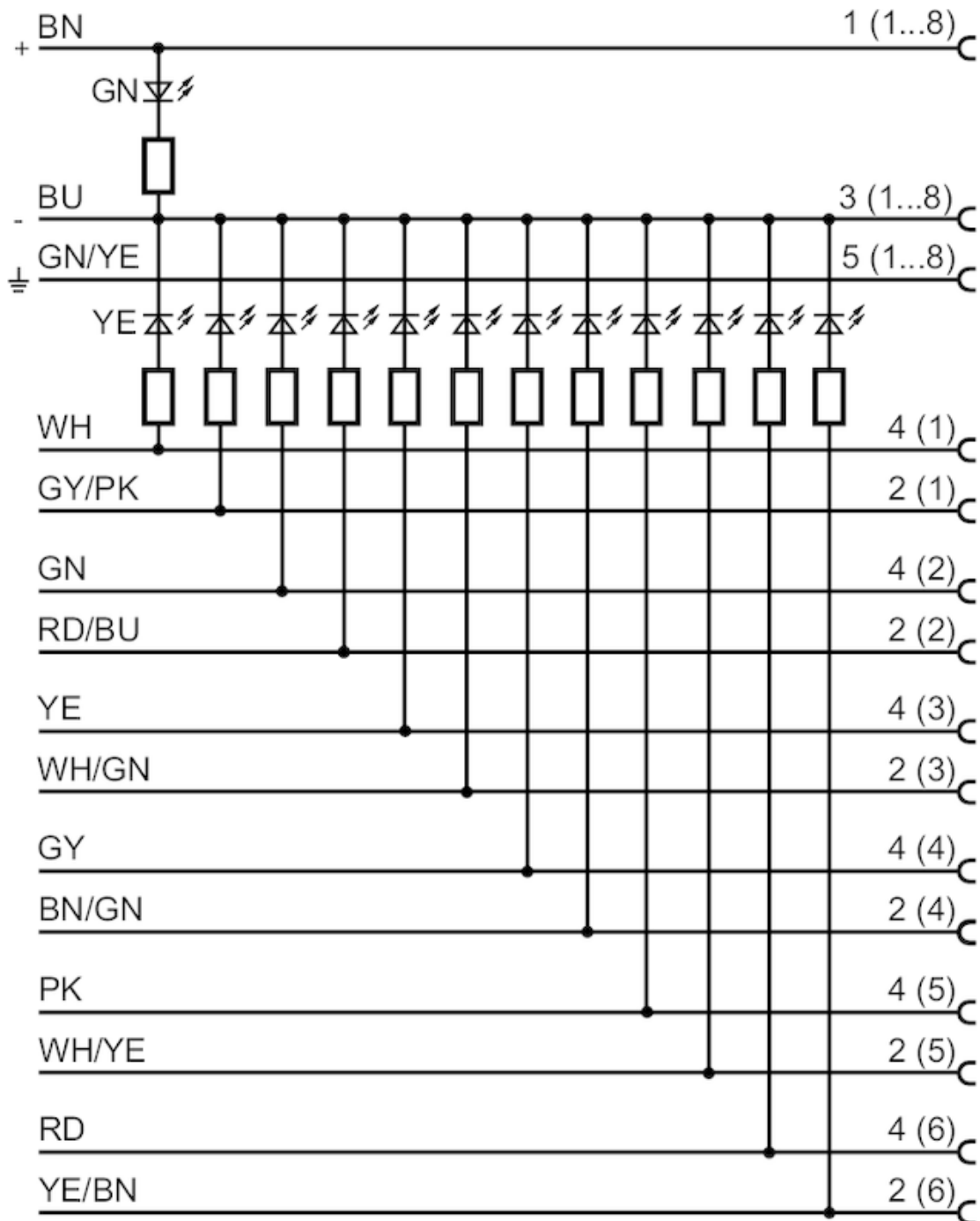

Core colours :

BN =

ifm electronic gmbh, Friedrichstraße 1 • 45128 Essen — We reserve the right to make technical alterations without prior notice. — EN-GB — EBC032-01 — 01.03.2013

BU =

blue

GN =

green

# EBC032

## Splitter box

ZDO6H05DMSS0010H15

