

# Absolute encoders - SSI

Blind hollow shaft or cone shaft (1:10)

ST and MT 20 bit / Speed switch

SSI absolut value, number of pulses and switching speed freely programmable

## HMG10P-B - SSI



HMG10P-B - picture similar

### Features

- Magnetic sensing method
- Singleturn/multiturn 20 bit programmable
- Function display via LEDs
- Multiturn sensing with Energy Harvesting technology, without gear or battery
- Two-sided bearing system with hybrid bearings
- Special protection against corrosion C5-M

### Optional

- Integrated speed switch programmable
- Additional outputs incremental programmable

### Technical data - electrical ratings

Voltage supply	4.75...30 VDC
Short-circuit proof	Yes
Consumption w/o load	≤100 mA (SSI)
Initializing time	≤500 ms after power on
Interface	SSI
Steps per revolution	1048576 / 20 bit
Number of revolutions	1048576 / 20 bit
Additional outputs	Square-wave TTL/HTL, TTL/RS422
Sensing method	Magnetic
Code	Gray (fact. setting) or binary
Code sequence	CW (fact. setting), programmable
Input signals	SSI clock, PRESET, rotating direction
Interference immunity	EN 61000-6-2
Emitted interference	EN 61000-6-3
Programming interface	RS485 (≤600 m)
Programmable parameters	Resolution singleturn and multiturn (SSI), binary or gray code (SSI), additional output (no. of pulses), switch-off and switch-on speeds
Diagnostic function	Function control
Status indicator	4 LEDs in device back side
Approvals	CE, UL approval / E256710

### Technical data - electrical ratings (speed switches)

Switching accuracy	±2 % (or 1 Digit)
Switching outputs	1 output (Open collector, solid state relay on request)
Output switching capacity	30 VDC; ≤100 mA
Switching delay time	≤20 ms

### Technical data - mechanical design

Size (flange)	ø105 mm
Shaft type	ø16...20 mm (blind hollow shaft) ø17 mm (cone shaft 1:10)
Flange	Support plate, 360° freely positionable
Protection DIN EN 60529	IP 66/IP 67
Operating speed	≤12000 rpm
Range of switching speed	ns (off) = ±2...12000 rpm, factory setting 6000 rpm
Operating torque typ.	10 Ncm
Rotor moment of inertia	950 gcm <sup>2</sup>
Admitted shaft load	≤450 N axial ≤650 N radial
Materials	Housing: aluminium alloy Shaft: stainless steel
Corrosion protection	IEC 60068-2-52 Salt mist for ambient conditions C5-M (CX) according to ISO 12944-2
Operating temperature	-40...+95 °C
Relative humidity	95 % non-condensing
Resistance	IEC 60068-2-6 Vibration 30 g, 10-2000 Hz IEC 60068-2-27 Shock 400 g, 1 ms
Weight approx.	1.6 kg (depending on version)
Connection	Terminal box Flange connector M23

# Absolute encoders - SSI

Blind hollow shaft or cone shaft (1:10)

ST and MT 20 bit / Speed switch

SSI absolut value, number of pulses and switching speed freely programmable

HMG10P-B - SSI

## Part number

HMG10P 

	-BH	.		UG	.	3	6	0			.G
--	-----	---	--	----	---	---	---	---	--	--	----

### Additional output 2\*

- 0 Without
- 5 1024 ppr\*\* TTL/HTL (Vin=Vout), 6 channels, electrically isolated
- 6 1024 ppr\*\* TTL/RS422, 6 channels

### Additional output 1

- 0 Without
- 5 1024 ppr\*\* TTL/HTL (Vin=Vout), 4 channels
- 6 1024 ppr\*\* TTL/RS422, 4 channels

### Resolution speed

- 0 Without \*\*

### Resolution multiturn

- 6 16 bit \*\*

### Resolution singleturn

- 3 13 bit \*\*

### Voltage supply / interface

UG 4,75...30 VDC, SSI Gray \*\*

### Connection

- 2 1x terminal box with cable gland M20, radial
- G 1x flange connector M23, radial, 17-pin, male, CW
- M 2x terminal box with cable gland M20, radial
- S 2x flange connector M23, radial (1x 17-pin, male, CW + 1x 12-pin, male, CW)

### Shaft diameter

- 6 ø16 mm, central screw
- 7 ø17 mm cone 1:10, central screw
- Z ø20 mm, central screw

### Protection

- D IP 66 and IP 67, optimized for dusty environments
- L IP 66 and IP 67, optimized for oily and wet environments

### Speed switch\*

- Without
- D With speed switch / switching speed 6000 rpm\*\*  
(Standard: Open collector, solid state relay on request)

\* Only for connection 2x terminal box (M) or 2x flange connector (S)

\*\* Factory setting, programmable

# Absolute encoders - SSI

Blind hollow shaft or cone shaft (1:10)

ST and MT 20 bit / Speed switch

SSI absolut value, number of pulses and switching speed freely programmable

## HMG10P-B - SSI

### Terminal significance

Ub	Voltage supply
0V	Ground
A+ <sup>2)</sup>	Output signal channel 1
A- <sup>2)</sup>	Output signal channel 1 inverted
B+ <sup>2)</sup>	Output signal channel 2 (offset by 90° to channel 1)
B- <sup>2)</sup>	Output signal channel 2 inverted
R+ <sup>2)</sup>	Zero pulse (reference signal)
R- <sup>2)</sup>	Zero pulse inverted
nE+	System OK+ / error output
nE-	System OK- / error output inverted
PRE	PRESET/RESET
DIR	Rotating direction
SP+ <sup>3)</sup>	DSL_OUT1 / speed switch (Open collector, solid state relay on request)
SP- <sup>3)</sup>	DSL_OUT2 / speed switch (0V, solid state relay on request)
SA	RS485+ / programming interface
SB	RS485- / programming interface
D+	SSI data+
D-	SSI data-
C+	SSI clock+
C-	SSI clock-
dnu	Do not use

### Terminal assignment flange connectors

#### View C<sup>1)</sup>

SSI, programming interface, additional output incremental 1

1	nE-	1	dnu / B- <sup>2)</sup>
2	DIR	2	nE-
3	SB	3	dnu / R+ <sup>2)</sup>
4	nE+	4	dnu / R- <sup>2)</sup>
5	PRE	5	dnu / A+ <sup>2)</sup>
6	SA	6	dnu / A- <sup>2)</sup>
7	Ub	7	dnu / SP+ <sup>3)</sup>
8	C+	8	dnu / B+ <sup>2)</sup>
9	C-	9	dnu / SP- <sup>3)</sup>
10	0V	10	0V <sup>2)</sup>
11	Internal shield	11	nE+
12	dnu / B+ <sup>2)</sup>	12	Ub <sup>2)</sup>
13	dnu / B- <sup>2)</sup>		
14	D+		
15	dnu / A+ <sup>2)</sup>		
16	dnu / A- <sup>2)</sup>		
17	D-		

#### View D<sup>1)</sup>

Additional output incremental 2, speed switch

### Terminal assignment terminal box

View A<sup>1)</sup> - SSI, programming interface, additional output incremental 1

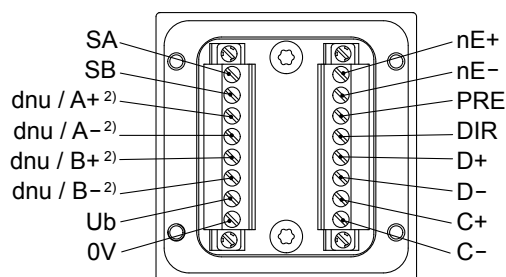

View B<sup>1)</sup> - Additional output incremental 2, speed switch

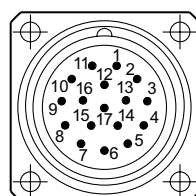
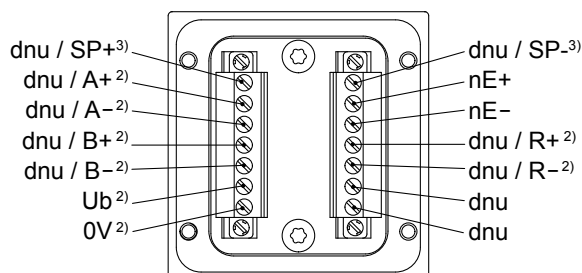

Flange connector M23 (male, 17-pin) Clockwise (CW)

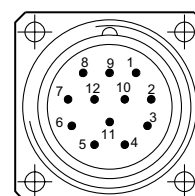

Flange connector M23 (male, 12-pin) Clockwise (CW)

<sup>1)</sup> See dimensions

<sup>2)</sup> Additional output incremental (option)

<sup>3)</sup> Speed switch (option)

# Absolute encoders - SSI

## Blind hollow shaft or cone shaft (1:10)

### ST and MT 20 bit / Speed switch

SSI absolut value, number of pulses and switching speed freely programmable

HMG10P-B - SSI

#### Data transfer

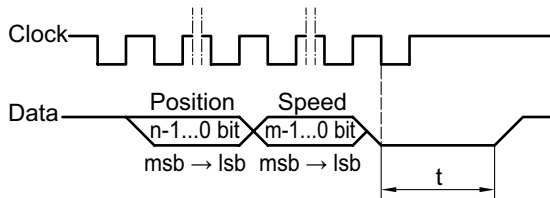

Clock frequency	100 kHz...2 MHz
Monoflop time (t)	20 $\mu$ s (internal)
n, m	Number of bits
For continuous clocking, the SSI word is transmitted only once followed by zero values (no ring register operation).	

#### Speed switch - Switching characteristics

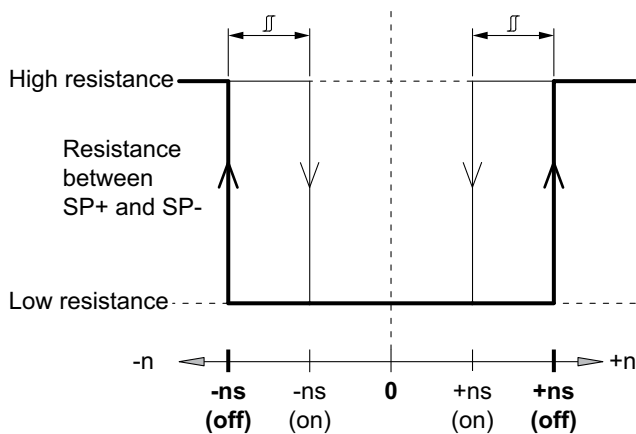

- n = Speed
- +ns (off)** = Switch-off speed at shaft rotation in positive rotating direction <sup>1)</sup>.
- ns (off)** = Switch-off speed at shaft rotation in negative rotating direction <sup>1)</sup>.
- Switching hysteresis  $\square$ :  
5...100 % (factory setting = 10 % min. 1 Digit)
- +ns (on)** = Switch-on speed at shaft rotation in positive rotating direction <sup>1)</sup>.
- ns (on)** = Switch-on speed at shaft rotation in negative rotating direction <sup>1)</sup>.

#### Additional output incremental - Output signals

Version with additional output incremental at positive rotating direction <sup>1)</sup>

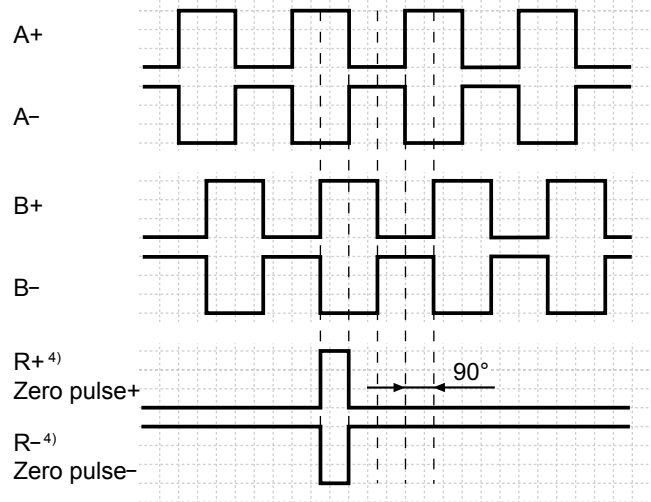

#### Additional output incremental - Trigger level

<b>Trigger level</b>	<b>TTL/RS422</b>
High / Low	$\geq 2.5$ V / $\leq 0.5$ V
Transmission length	$\leq 550$ m @ 100 kHz
Output frequency	$\leq 600$ kHz
<b>Trigger level</b>	<b>TTL/HTL (Vin = Vout)</b>
High / Low	$\geq 2.5$ V / $\leq 0.5$ V (TTL) $\geq U_b - 3$ V / $\leq 1.5$ V (HTL)
Transmission length	$\leq 550$ m @ 100 kHz (TTL) $\leq 350$ m @ 100 kHz (HTL)
Output frequency	$\leq 600$ kHz (TTL) $\leq 350$ kHz (HTL)

Electrically isolated:  
The output TTL/HTL (Vin = Vout) at the additional output incremental 2 is electrically isolated and requires a separate power supply.

<sup>1)</sup> See dimensions

<sup>4)</sup> Only additional output incremental 2

# Absolute encoders - SSI

Blind hollow shaft or cone shaft (1:10)

ST and MT 20 bit / Speed switch

SSI absolut value, number of pulses and switching speed freely programmable

## HMG10P-B - SSI

### Accessories

#### Connectors and cables

HEK 8	Sensor cable for encoders
HEK 17	Sensor cable for encoders
11068577	Mating connector M23, solder version, 12-pin, CCW
11068551	Mating connector M23, solder version, 17-pin, CCW
11172482	Mating connector M23 (11 pins assigned) 17-pin, CCW with sensor cable HEK 17, <b>length 1 m</b>
11172481	Mating connector M23 (11 pins assigned) 17-pin, CCW with sensor cable HEK 17, <b>length 3 m</b>
11172499	Mating connector M23 (11 pins assigned) 17-pin, CCW with sensor cable HEK 17, <b>length 5 m</b>
11172580	Mating connector M23 (11 pins assigned) 17-pin, CCW with sensor cable HEK 17, <b>length 10 m</b>
11172463	Mating connector M23 (17 pins assigned) 17-pin, CCW with sensor cable HEK 17, <b>length 3 m</b>
11191143	Adapter cable for programming the HMG10P/ PMG10P SSI series with flange connector/s Mating connector M23, 17-pin, CCW with connecting cable and D-SUB connector (male) 15-pin, tee connector M23, 3x 17-pin
11191144	Adapter cable for programming the HMG10P/ PMG10P SSI series with terminal box D-SUB connector (male) 15-pin with connecting cable and 8-pin connecting terminal

#### Mounting accessories

11043628	Torque arm M6, length 67-70 mm
11004078	Torque arm M6, length 120-130 mm (shortenable $\geq 71$ mm)
11002915	Torque arm M6, length 425-460 mm (shortenable $\geq 131$ mm)
11054917	Torque arm M6 insulated, length 67-70 mm
11072795	Torque arm M6 insulated, length 120-130 mm (shortenable $\geq 71$ mm)
11082677	Torque arm M6 insulated, length 425-460 mm (shortenable $\geq 131$ mm)
11077197	Mounting kit for torque arm size M6 and earthing strap
11077087	Mounting and dismounting set

#### Programming accessories

11190106	Z-PA.SDL.1 - <i>WLAN-Adapter</i> Programming unit for xMG10P series
----------	--

# Absolute encoders - SSI

Blind hollow shaft or cone shaft (1:10)

ST and MT 20 bit / Speed switch

SSI absolut value, number of pulses and switching speed freely programmable

HMG10P-B - SSI

## Dimensions

### With radial terminal boxes

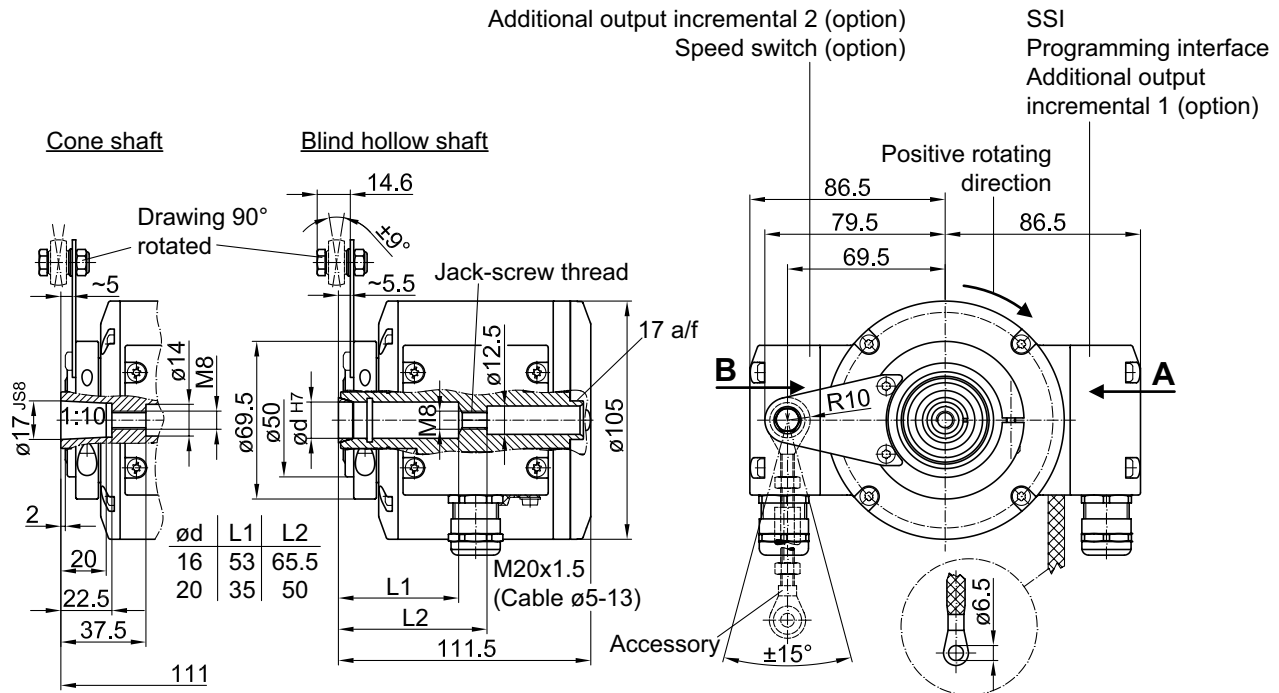

### With radial flange connectors M23

