



## Safety light curtains C4000 Advanced without extension connection

C40E-1302CB010, C40S-1302CA010



**receiver**

Model Name > C40E-1302CB010  
Part No. > 1018799



**sender**

Model Name > C40S-1302CA010  
Part No. > 1018627



**At a glance**

- Type 4 (IEC 61496), PL e (EN ISO 13849)
- Various options for blanking objects: fixed, floating, or teach-in
- 7-segment display
- PSDI mode with the UE402 switching amplifier
- External device monitoring (EDM) and restart interlock (RES)
- Beam coding for correct system allocation
- Configuration and diagnostics via PC
- Cascade up to three systems

**Your benefits**

- Blanking functions enable reliable and safe object detection and increase the productivity in the process
- 7-segment display saves time during alignment and diagnostics
- Beam coding protects the systems against optical interference by ensuring a high level of availability
- Clone plug enables easy and rapid commissioning, saving time and costs
- Ability to cascade up to three systems optimizes the safety application and reduces wiring costs
- Precise, convenient configuration and diagnostics reduce downtime



**Functions-Sender**

Beam coding:	✓
Reduced resolution:	-
Configuration method:	PC with CDS (Configuration and Diagnostic Software)
Extension connection:	-
PSDI mode with:	UE402
Safe SICK device communication via EFI/SDL:	✓

## Functions-Receiver

---

Restart interlock:	✓
Restart interlock (delivery status):	External
External device monitoring (EDM):	✓
External device monitoring (delivery status):	Deactivated
Beam coding:	✓
Beam coding (delivery status):	Non-coded
Reduced resolution:	✓
Bypass (with UE402):	✓
Emergency stop/bypass at extension connection:	-
Operating mode switching (with UE402):	✓
PSDI mode with:	UE402
Muting with:	Flexi Classic
Configuration method:	PC with CDS (Configuration and Diagnostic Software)
Extension connection:	-
Safe SICK device communication via EFI/SDL:	✓

## Technical Data-Sender

---

Protective field height:	1,350 mm
Resolution:	20 mm
Housing length:	1,481 mm
Housing cross-section:	48 mm x 40 mm
Type:	Type 4 (IEC 61496)
Safety integrity level:	SIL3 (IEC 61508), SILCL3 (IEC 62061)
Category:	category 4 (EN ISO 13849)
Performance level:	PL e (EN ISO 13849)
PFHd:	1.5 * 1E-08
TM (mission time):	20 a
Supply voltage typical, from, to:	24 V DC, 19.2 V DC, 28.8 V DC
Connection type:	Hirschmann plug M26 x 11 + FE, straight
Connection type configuration connection:	M8 x 4
Maximum connection cable cross-section:	0.75 mm <sup>2</sup>
Wave length:	950 nm
Protection class:	III (EN 50178)
Enclosure rating:	IP 65 (EN 60529)
Ambient operating temperature:	0 °C ... 55 °C
Vibration resistance (checked to):	5 g (IEC 60068-2-6)
Oscillation frequency from ... to:	10 Hz ... 55 Hz
Shock resistance:	10 g, 16 ms (IEC 60068-2-29)
Weight:	2,820 g

## Technical Data-Receiver

---

Protective field height:	1,350 mm
Resolution:	20 mm
Scanning range from ... to:	0 m ... 19 m
Scanning range from ... to (delivery status):	0 m ... 6 m
Housing length:	1,481 mm
Housing cross-section:	48 mm x 40 mm
Type:	Type 4 (IEC 61496)
Safety integrity level:	SIL3 (IEC 61508), SILCL3 (IEC 62061)

Category:	category 4 (EN ISO 13849)
Performance level:	PL e (EN ISO 13849)
PFHd:	1.5 * 1E-08
TM (mission time):	20 a
Supply voltage typical, from, to:	24 V DC, 19.2 V DC, 28.8 V DC
Response time without beam coding:	≤ 18 ms
Response time with beam coding:	≤ 36 ms
Maximum switching current:	500 mA
Wave length:	950 nm
Connection type:	Hirschmann plug M26 x 11 + FE, straight
Connection type configuration connection:	M8 x 4
Maximum connection cable cross-section:	0.75 mm <sup>2</sup>
Protection class:	III (EN 50178)
Enclosure rating:	IP 65 (EN 60529)
Ambient operating temperature:	0 °C ... 55 °C
Vibration resistance (checked to):	5 g (IEC 60068-2-6)
Oscillation frequency from ... to:	10 Hz ... 55 Hz
Shock resistance:	10 g, 16 ms (IEC 60068-2-29)
Weight:	2,850 g

## Dimensional drawing

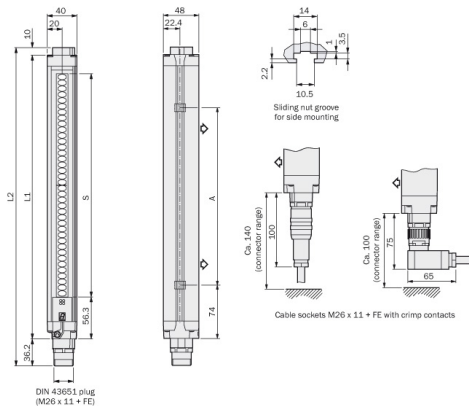

**Australia**

Phone +61 3 9457 0600  
1800 33 48 02 – tollfree  
E-Mail sales@sick.com.au

**Belgium/Luxembourg**

Phone +32 (0)2 466 55 66  
E-Mail info@sick.be

**Brasil**

Phone +55 11 3215-4900  
E-Mail marketing@sick.com.br

**Canada**

Phone +1 905 771 14 44  
E-Mail information@sick.com

**Česká republika**

Phone +420 2 57 91 18 50  
E-Mail sick@sick.cz

**China**

Phone +86 4000 121 000  
E-Mail info.china@sick.net.cn  
Phone +852-2153 6300  
E-Mail ghk@sick.com.hk

**Danmark**

Phone +45 45 82 64 00  
E-Mail sick@sick.dk

**Deutschland**

Phone +49 211 5301-301  
E-Mail info@sick.de

**España**

Phone +34 93 480 31 00  
E-Mail info@sick.es

**France**

Phone +33 1 64 62 35 00  
E-Mail info@sick.fr

**Great Britain**

Phone +44 (0)1727 831121  
E-Mail info@sick.co.uk

**India**

Phone +91-22-4033 8333  
E-Mail info@sick-india.com

**Israel**

Phone +972-4-6881000  
E-Mail info@sick-sensors.com

**Italia**

Phone +39 02 27 43 41  
E-Mail info@sick.it

**Japan**

Phone +81 (0)3 5309 2112  
E-Mail support@sick.jp

**Magyarország**

Phone +36 1 371 2680  
E-Mail office@sick.hu

**Nederland**

Phone +31 (0)30 229 25 44  
E-Mail info@sick.nl

**Norge**

Phone +47 67 81 50 00  
E-Mail sick@sick.no

**Österreich**

Phone +43 (0)22 36 62 28 8-0  
E-Mail office@sick.at

**Polska**

Phone +48 22 837 40 50  
E-Mail info@sick.pl

**România**

Phone +40 356 171 120  
E-Mail office@sick.ro

**Russia**

Phone +7-495-775-05-30  
E-Mail info@sick.ru

**Schweiz**

Phone +41 41 619 29 39  
E-Mail contact@sick.ch

**Singapore**

Phone +65 6744 3732  
E-Mail sales.gsg@sick.com

**Slovenija**

Phone +386 (0)1-47 69 990  
E-Mail office@sick.si

**South Africa**

Phone +27 11 472 3733  
E-Mail info@sickautomation.co.za

**South Korea**

Phone +82 2 786 6321/4  
E-Mail info@sickkorea.net

**Suomi**

Phone +358-9-25 15 800  
E-Mail sick@sick.fi

**Sverige**

Phone +46 10 110 10 00  
E-Mail info@sick.se

**Taiwan**

Phone +886 2 2375-6288  
E-Mail sales@sick.com.tw

**Türkiye**

Phone +90 (216) 528 50 00  
E-Mail info@sick.com.tr

**United Arab Emirates**

Phone +971 (0) 4 88 65 878  
E-Mail info@sick.ae

**USA/México**

Phone +1(952) 941-6780  
1 (800) 325-7425 – tollfree  
E-Mail info@sickusa.com

More representatives and agencies  
at [www.sick.com](http://www.sick.com)