

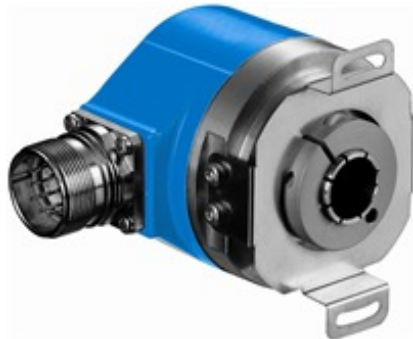

**Absolute encoders
ARS60 SSI/Parallel**

ARS60-FAL00060



Model Name > [ARS60-FAL00060](#)
Part No. > [1034889](#)



Illustration may differ

At a glance

- Absolute singleturn encoder
- Resolution: up to 15 bits (32,768 increments)
- Electrical interface: SSI with gray code type or gray capped
- Electrical interface: Parallel with gray, gray capped, binary, BCD code type
- Zero-set function
- Mechanical interfaces: face mount flange, servo flange, blind and through hollow shaft
- Enclosure rating: Up to IP66

Your benefits

- Optical and magnetic variants for the widest range of requirements
- Reduced maintenance costs thanks to magnetic, wearless scanning in single and multiturn design
- High level of productivity due to optical encoders with a high level of precision and fast calculation of positions
- Robust design for maximum system availability, even in extreme environmental conditions
- Absolutely compact - specially suited in cases where installation space is tight
- Flexible integration in all common networks



Performance

Max. number of steps per revolution:	60
Max. number of revolutions:	1
Resolution power:	60 x 1
Error limits:	0.035 ° (binary number of steps) 0.046 ° (non-binary number of steps)
Repeatability (Ta not constant):	0.005 °
Measuring step deviation:	0.005 °, 0.016 °
Measuring step:	360 ° /number of lines
Initialization time:	80 ms ¹⁾

¹⁾ Valid positional data can be read once this time has elapsed

Mechanical data

Mechanical interface: Blind hollow shaft

Shaft diameter:	6 mm 8 mm 10 mm 12 mm 14 mm 15 mm 1/4 " 3/8 " ¹⁾ 1/2 " ¹⁾
Start up torque:	0.6 Ncm
Operating torque:	0.4 Ncm
Maximum operating speed:	3,000 /min
Bearing lifetime:	3.6 x 10 ⁹ revolutions
Max. angular acceleration:	500,000 rad/s ²
Permissible movement axial static/dynamic:	± 0.5 mm, ± 0.2 mm
Permissible movement radial static/dynamic:	± 0.3 mm, ± 0.1 mm
Operation of zero-set:	≥ 100 ms ²⁾

¹⁾ Collets for 6, 8, 10, 12, 14 mm and 1/4 ", 3/8 " and 1/2 " as accessories, separate order item. For 15 mm shaft diameter collet is not needed. ²⁾ Only with shaft stationary (note initialisation time)

Electrical data

Operating voltage range:	10 V DC ... 32 V DC
Operating power consumption (no load):	90 mA
MTTFd: mean time to dangerous failure:	300 a (EN ISO 13849-1) ¹⁾

¹⁾ This product is a standard product and does not constitute a safety component as defined in the Machinery Directive.

Calculation based on nominal load of components, average ambient

temperature 40°C, frequency of use 8760 h/a. All

electronic failures are considered hazardous. For more information, see document no. 8015532.

Interfaces

Electrical interface:	Cable, 22-pin, radial, 3 m
-----------------------	----------------------------

Ambient data

EMC:	(according to EN 61000-6-2 and EN 61000-6-3) ¹⁾
Enclosure rating:	IP 66 (according to IEC 60529)
Permissible relative humidity:	90 % (condensation of the optical scanning not permitted)
Working temperature range:	-20 °C ... 85 °C
Storage temperature range:	-40 °C ... 100 °C
Resistance to shocks:	50 g (according to EN 60068-2-27)
Resistance to vibration:	20 g, 10 Hz ... 2,000 Hz (according to EN 60068-2-6)

¹⁾

Dimensional drawing

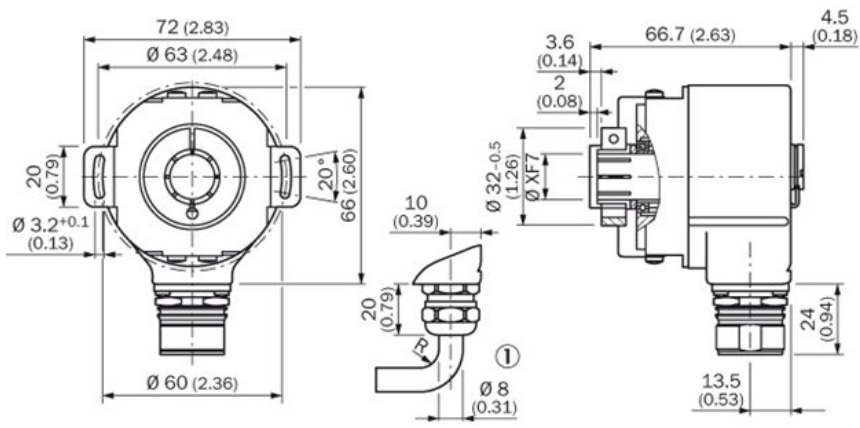

Drehzahlbetrachtung

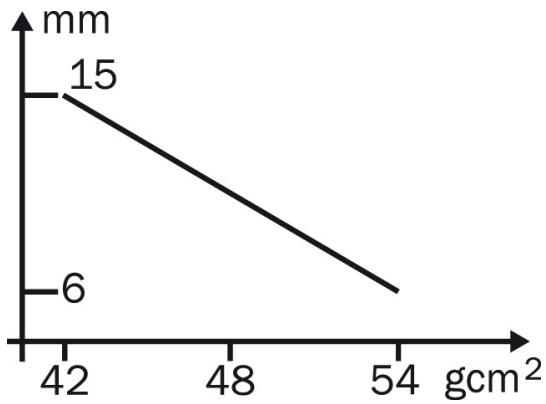

Australia

Phone +61 3 9457 0600
1800 334 802 – tollfree
E-Mail sales@sick.com.au

Belgium/Luxembourg

Phone +32 (0)2 466 55 66
E-Mail info@sick.be

Brasil

Phone +55 11 3215-4900
E-Mail sac@sick.com.br

Canada

Phone +1 905 771 14 44
E-Mail information@sick.com

Ceská Republika

Phone +420 2 57 91 18 50
E-Mail sick@sick.cz

China

Phone +86 4000 121 000
E-Mail info.china@sick.net.cn
Phone +852-2153 6300
E-Mail ghk@sick.com.hk

Danmark

Phone +45 45 82 64 00
E-Mail sick@sick.dk

Deutschland

Phone +49 211 5301-301
E-Mail kundenservice@sick.de

España

Phone +34 93 480 31 00
E-Mail info@sick.es

France

Phone +33 1 64 62 35 00
E-Mail info@sick.fr

Great Britain

Phone +44 (0)1727 831121
E-Mail info@sick.co.uk

India

Phone +91-22-4033 8333
E-Mail info@sick-india.com

Israel

Phone +972-4-6801000
E-Mail info@sick-sensors.com

Italia

Phone +39 02 27 43 41
E-Mail info@sick.it

Japan

Phone +81 (0)3 3358 1341
E-Mail support@sick.jp

Magyarország

Phone +36 1 371 2680
E-Mail office@sick.hu

Nederlands

Phone +31 (0)30 229 25 44
E-Mail info@sick.nl

Norge

Phone +47 67 81 50 00
E-Mail austefjord@sick.no

Österreich

Phone +43 (0)22 36 62 28 8-0
E-Mail office@sick.at

Polska

Phone +48 22 837 40 50
E-Mail info@sick.pl

România

Phone +40 356 171 120
E-Mail office@sick.ro

Russia

Phone +7-495-775-05-30
E-Mail info@sick.ru

Schweiz

Phone +41 41 619 29 39
E-Mail contact@sick.ch

Singapore

Phone +65 6744 3732
E-Mail admin@sicksgp.com.sg

Slovenija

Phone +386 (0)1-47 69 990
E-Mail office@sick.si

South Africa

Phone +27 11 472 3733
E-Mail info@sickautomation.co.za

South Korea

Phone +82 2 786 6321/4
E-Mail info@sickkorea.net

Suomi

Phone +358-9-25 15 800
E-Mail sick@sick.fi

Sverige

Phone +46 10 110 10 00
E-Mail info@sick.se

Taiwan

Phone +886-2-2375-6288
E-Mail sales@sick.com.tw

Türkiye

Phone +90 (216) 528 50 00
E-Mail info@sick.com.tr

United Arab Emirates

Phone +971 (0) 4 8865 878
E-Mail info@sick.ae

USA/México

Phone +1(952) 941-6780
1 800-325-7425 – tollfree
E-Mail info@sickusa.com

More representatives and agencies
at www.sick.com