



Pressure sensors
Pressure switch

PBS-RB040SG1SSND5A0Z



Model Name > **PBS-RB040SG1SSND5A0Z**
Part No. > **6038916**



Product may differ from illustration

At a glance

- Gauge measurement ranges from 0 ... 1 bar up to 0 ... 600 bar
- No moving parts: No mechanical wear, fatigue-proof, maintenance-free
- Stainless steel membrane
- Various programmable switching functions
- Digital outputs PNP or NPN, Analog output signal 4 ... 20 mA or 0 ... 10 V
- Min/max pressure memory
- Password protection
- Selection of different pressure units for the display
- IO-Link optional

Your benefits

- Compact size takes up less space
- Dual rotatable housing ensures flexible installation
- Quick and easy setup and operation due to three large buttons and bright display
- Wide range of applications
- Resistant against corrosive media due to circularly welded, hermetically sealed stainless steel membrane
- Available in a wide selection of configurations, enabling a perfect match to individual customer requirements
- IO-Link technology provides time and cost savings by enabling parameter adjustments, for example, upon product changeover to be performed remotely



Features

Pressure type:	Gauge pressure
Measuring range:	0 bar ... 40 bar
Process temperature:	-20 °C ... 85 °C
Rated temperature:	0 °C ... 80 °C
CE-conformity:	✓
Display:	14-segment-LED, blue, 4-digits, height 9 mm, electronically turnable by 180°, Update: 1000, 500, 200, 100 ms (adjustable), Accuracy: ≤ 1.0 % of span ± 1 digit
Output signal:	2x PNP + 4...20 mA

Performance

Accuracy:	≤ +/- 1 % (of span)
Non-linearity:	0.5 % (Best Fit Straight Line (BFSL))

Mechanics/electronics

Process connection:	G 1/4 A (DIN 3852-E)
Wetted parts:	Pressure Connection: 316L, Pressure sensor: 316 L (for measurement ranges from 0 ... 10 bar rel: 13-8 PH)
Seal:	NBR
Housing material:	Display window: PC, Plastic head: PC + ABS, Buttons: TPE-E, Lower body: 316 L
Enclosure rating:	IP 67
Connection type:	Plug M12 x1, 5-pin
Supply voltage:	15 V DC ... 35 V DC
Power consumption:	100 mA
Electrical safety:	Short-circuit protection: QA, Q1, Q2 towards M, Protection class: III, Overvoltage protection: 40 V DC, Reverse polarity protection: L+ towards M
Protection class III:	✓

Ambient data

Ambient temperature:	-20 °C ... 80 °C
Shock load:	50 g according to IEC 60068-2-27 (mechanical shock)
Vibration load:	10 g according to IEC 60068-2-6 (vibration under resonance)

Dimensional drawing housing

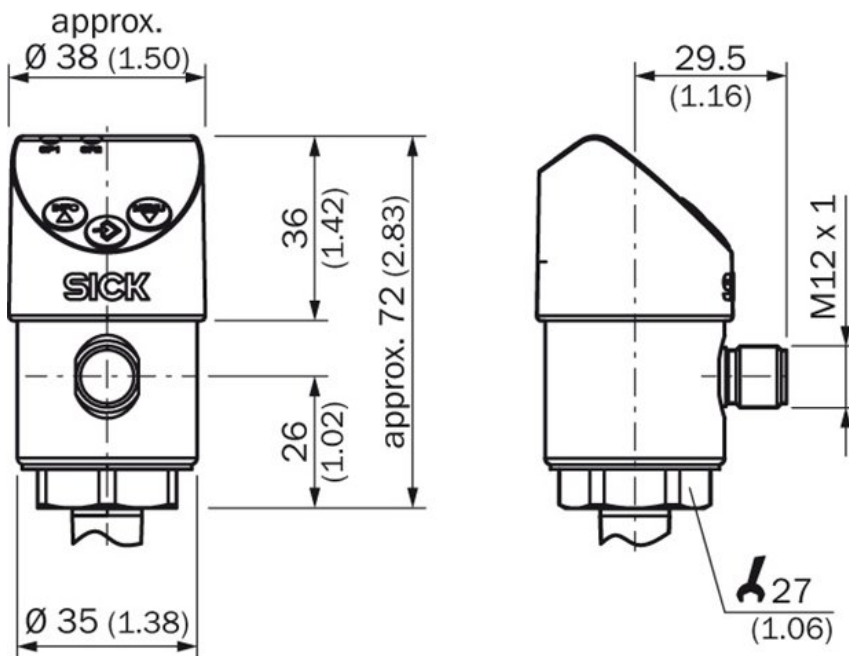

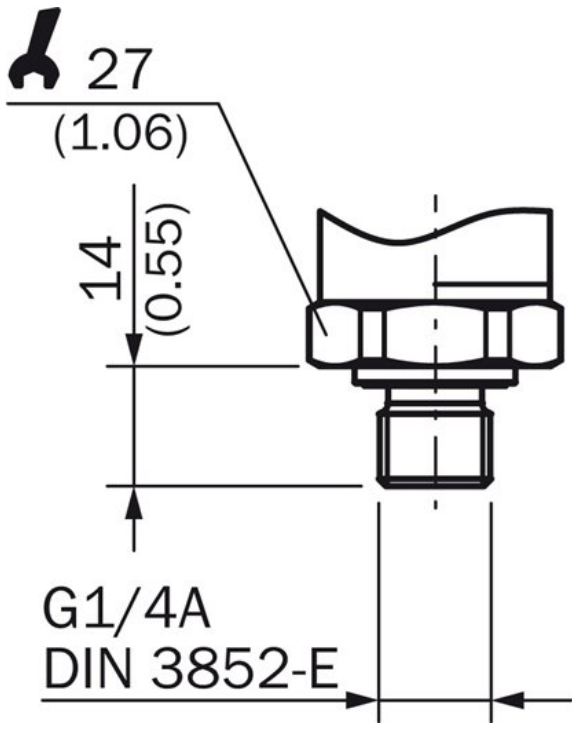

Australia

Phone +61 3 9457 0600
1800 334 802 – tollfree
E-Mail sales@sick.com.au

Belgium/Luxembourg

Phone +32 (0)2 466 55 66
E-Mail info@sick.be

Brasil

Phone +55 11 3215-4900
E-Mail sac@sick.com.br

Canada

Phone +1 905 771 14 44
E-Mail information@sick.com

Ceská Republika

Phone +420 2 57 91 18 50
E-Mail sick@sick.cz

China

Phone +86 4000 121 000
E-Mail info.china@sick.net.cn
Phone +852-2153 6300
E-Mail ghk@sick.com.hk

Danmark

Phone +45 45 82 64 00
E-Mail sick@sick.dk

Deutschland

Phone +49 211 5301-301
E-Mail kundenservice@sick.de

España

Phone +34 93 480 31 00
E-Mail info@sick.es

France

Phone +33 1 64 62 35 00
E-Mail info@sick.fr

Great Britain

Phone +44 (0)1727 831121
E-Mail info@sick.co.uk

India

Phone +91-22-4033 8333
E-Mail info@sick-india.com

Israel

Phone +972-4-6801000
E-Mail info@sick-sensors.com

Italia

Phone +39 02 27 43 41
E-Mail info@sick.it

Japan

Phone +81 (0)3 3358 1341
E-Mail support@sick.jp

Magyarország

Phone +36 1 371 2680
E-Mail office@sick.hu

Nederlands

Phone +31 (0)30 229 25 44
E-Mail info@sick.nl

Norge

Phone +47 67 81 50 00
E-Mail austefjord@sick.no

Österreich

Phone +43 (0)22 36 62 28 8-0
E-Mail office@sick.at

Polska

Phone +48 22 837 40 50
E-Mail info@sick.pl

România

Phone +40 356 171 120
E-Mail office@sick.ro

Russia

Phone +7-495-775-05-30
E-Mail info@sick.ru

Schweiz

Phone +41 41 619 29 39
E-Mail contact@sick.ch

Singapore

Phone +65 6744 3732
E-Mail admin@sicksgp.com.sg

Slovenija

Phone +386 (0)1-47 69 990
E-Mail office@sick.si

South Africa

Phone +27 11 472 3733
E-Mail info@sickautomation.co.za

South Korea

Phone +82 2 786 6321/4
E-Mail info@sickkorea.net

Suomi

Phone +358-9-25 15 800
E-Mail sick@sick.fi

Sverige

Phone +46 10 110 10 00
E-Mail info@sick.se

Taiwan

Phone +886-2-2375-6288
E-Mail sales@sick.com.tw

Türkiye

Phone +90 (216) 528 50 00
E-Mail info@sick.com.tr

United Arab Emirates

Phone +971 (0) 4 8865 878
E-Mail info@sick.ae

USA/México

Phone +1(952) 941-6780
1 800-325-7425 – tollfree
E-Mail info@sickusa.com

More representatives and agencies
at www.sick.com