



Photoelectric sensors
W9-3, Photoelectric proximity sensor,
Background suppression

WTB9-3F3111



Model Name > [WTB9-3F3111](#)
Part No. > [1058892](#)



Illustration may differ

At a glance

- High-performance proximity sensing in ultra-rugged VISTAL™ housing
- PinPoint LED for highly visible and precise light spot
- Two emitter LEDs for best-in-class background suppression
- Variable mounting with M3 or M4 hole pattern
- Wide range of connection options

Your benefits

- Rugged VISTAL™ housing provides reliable installation and operation
- Reliable object detection in all situations using best-in-class technology
- Quick and easy alignment with reliable object detection due to the highly visible PinPoint light spot
- M3 slotted hole mounting for multiple mounting possibilities
- One housing with a wide range of options makes machine integration easy
- Variety of accessories for quick and easy mounting



Features

Sensor/detection principle:	Photoelectric proximity sensor, Background suppression
Dimensions (W x H x D):	12.2 mm x 49.8 mm x 23.6 mm
Housing design (light emission):	Rectangular
Mounting hole:	M3
Sensing range max.:	20 mm ... 500 mm ¹⁾
Sensing range:	20 mm ... 250 mm
Type of light:	Infrared light
Light source:	LED ²⁾
Wave length:	850 nm
Adjustment:	Potentiometer, 5-turn
Light spot size (distance):	Ø 20 mm (250 mm)

¹⁾ Object with 90 % reflectance (referred to standard white DIN 5033) ²⁾ Average service life of 100,000 h at T_A = +25 °C

Mechanics/electronics

Supply voltage:	10 V DC ... 30 V DC ¹⁾
Ripple:	< 5 Vpp ²⁾
Power consumption:	≤ 30 mA ³⁾
Output type:	PNP ⁴⁾
Switching mode:	Dark-switching ⁵⁾

Output current I _{max} ..:	≤ 100 mA ⁶⁾
Response time:	< 0.5 ms ⁷⁾
Switching frequency:	1,000 Hz ⁸⁾
Connection type:	Cable with connector M8, 3-pin, 120 mm
Circuit protection:::	A, B, C ^{9) 10) 11)}
Protection class:	III
Weight:	80 g
Polarisation filter:	-
Housing material:	Plastic, VISTAL
Optics material:	PMMA
Enclosure rating:	IP 66 IP 67 IP 69K
Ambient operating temperature:	-40 °C ... 60 °C
Ambient storage temperature:	-40 °C ... 75 °C
UL File No.:	NRKH.E181493

1) Limit values, operation in short-circuit protected network max. 8 A 2) May not exceed or fall short of V_S tolerances 3) Without load 4) 5) Q = dark-switching 6) As of Tu 50 °C, a max. load current I_{max} = 50 mA is permitted 7) Signal transit time with resistive load 8) With light/dark ratio 1:1 9) A = V_S connections reverse-polarity protected 10) B = inputs and output reverse-polarity protected 11) C = interference suppression

Dimensional drawing

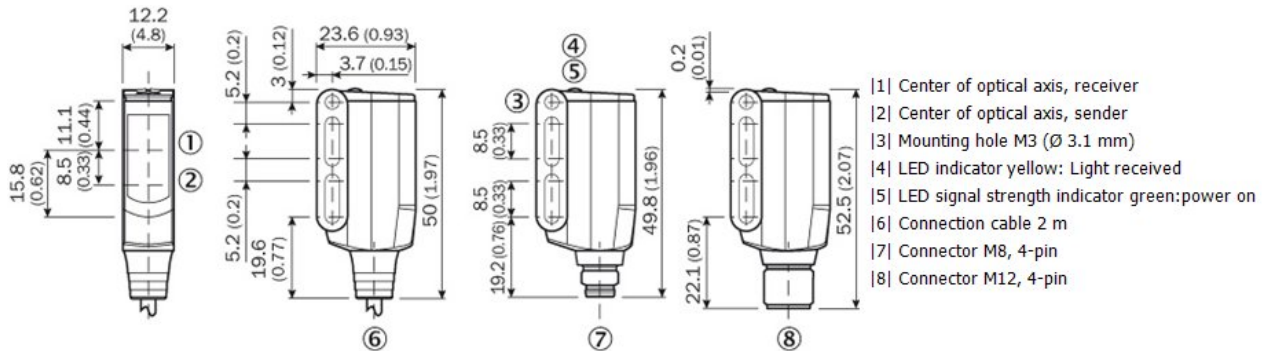

Adjustments possible

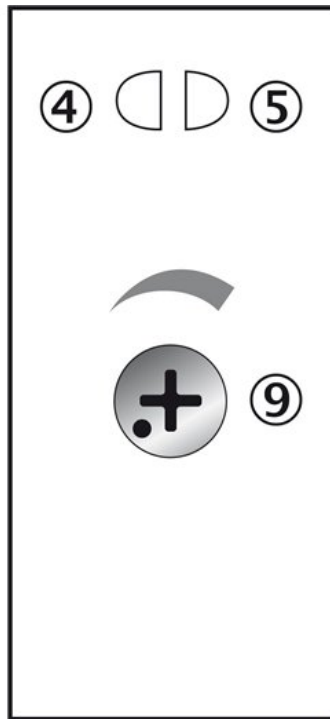

- |4| LED indicator yellow: Light received
- |5| LED signal strength indicator green: power on
- |9| Sensing range adjustment

Connection diagram

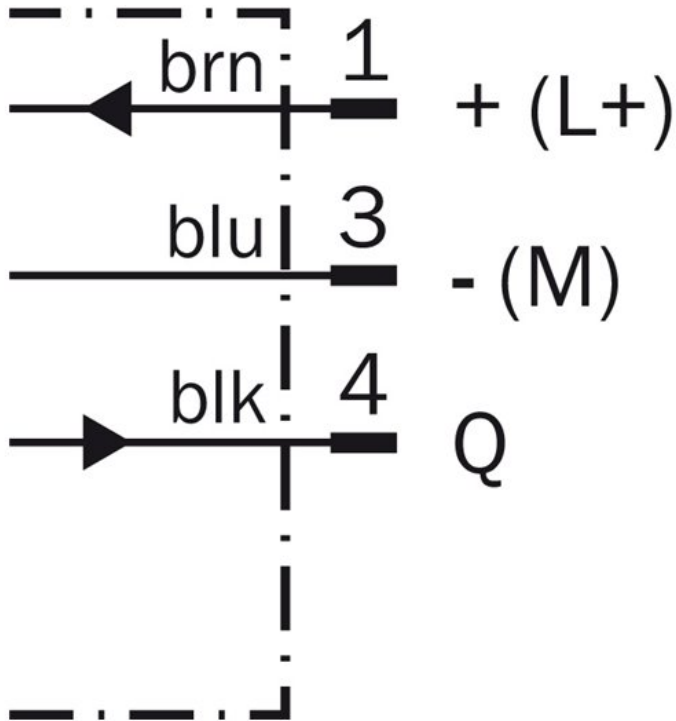

Characteristic curve

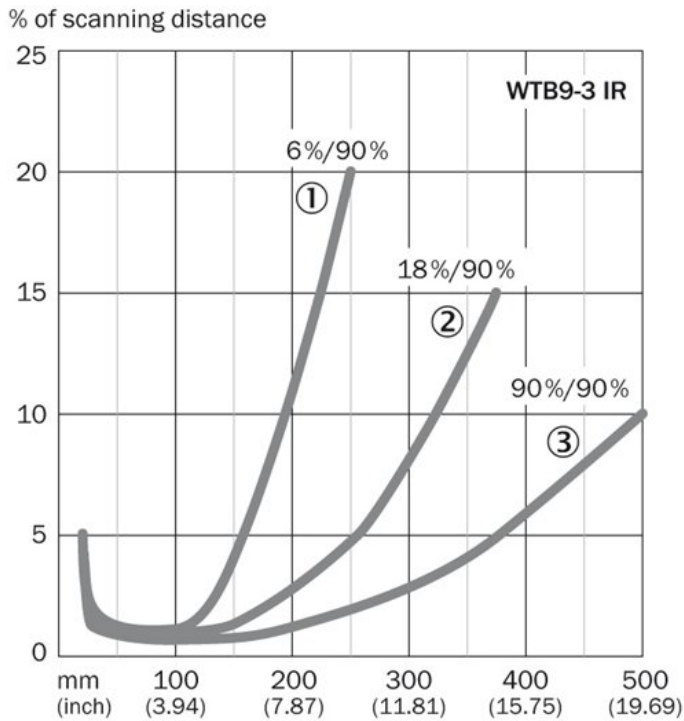

- |1| Sensing range on black, 6 % remission
- |2| Sensing range on grey, 18 % remission
- |3| Sensing range on white, 90 % remission

Connection type

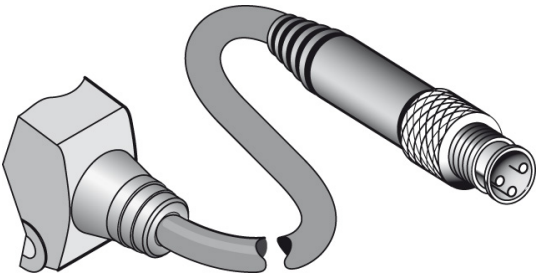

Light spot size

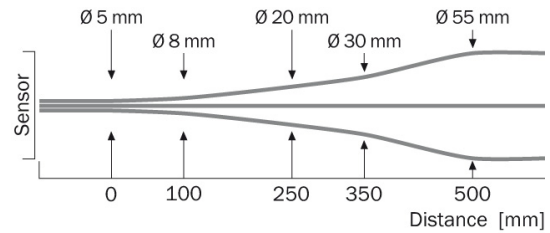

Sensing range diagram

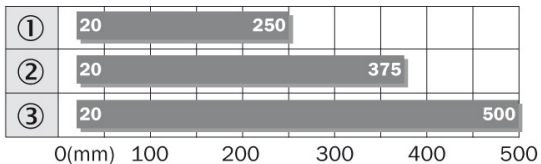

■ Operating distance

①	Scanning distance on black, 6% remission
②	Scanning distance on gray, 18% remission
③	Scanning distance on white, 90% remission

Australia

Phone +61 3 9457 0600
1800 334 802 – tollfree
E-Mail sales@sick.com.au

Belgium/Luxembourg

Phone +32 (0)2 466 55 66
E-Mail info@sick.be

Brasil

Phone +55 11 3215-4900
E-Mail sac@sick.com.br

Canada

Phone +1 905 771 14 44
E-Mail information@sick.com

Ceská Republika

Phone +420 2 57 91 18 50
E-Mail sick@sick.cz

China

Phone +86 4000 121 000
E-Mail info.china@sick.net.cn
Phone +852-2153 6300
E-Mail ghk@sick.com.hk

Danmark

Phone +45 45 82 64 00
E-Mail sick@sick.dk

Deutschland

Phone +49 211 5301-301
E-Mail kundenservice@sick.de

España

Phone +34 93 480 31 00
E-Mail info@sick.es

France

Phone +33 1 64 62 35 00
E-Mail info@sick.fr

Great Britain

Phone +44 (0)1727 831121
E-Mail info@sick.co.uk

India

Phone +91-22-4033 8333
E-Mail info@sick-india.com

Israel

Phone +972-4-6801000
E-Mail info@sick-sensors.com

Italia

Phone +39 02 27 43 41
E-Mail info@sick.it

Japan

Phone +81 (0)3 3358 1341
E-Mail support@sick.jp

Magyarország

Phone +36 1 371 2680
E-Mail office@sick.hu

Nederlands

Phone +31 (0)30 229 25 44
E-Mail info@sick.nl

Norge

Phone +47 67 81 50 00
E-Mail austefjord@sick.no

Österreich

Phone +43 (0)22 36 62 28 8-0
E-Mail office@sick.at

Polska

Phone +48 22 837 40 50
E-Mail info@sick.pl

România

Phone +40 356 171 120
E-Mail office@sick.ro

Russia

Phone +7-495-775-05-30
E-Mail info@sick.ru

Schweiz

Phone +41 41 619 29 39
E-Mail contact@sick.ch

Singapore

Phone +65 6744 3732
E-Mail admin@sicksgp.com.sg

Slovenija

Phone +386 (0)1-47 69 990
E-Mail office@sick.si

South Africa

Phone +27 11 472 3733
E-Mail info@sickautomation.co.za

South Korea

Phone +82 2 786 6321/4
E-Mail info@sickkorea.net

Suomi

Phone +358-9-25 15 800
E-Mail sick@sick.fi

Sverige

Phone +46 10 110 10 00
E-Mail info@sick.se

Taiwan

Phone +886-2-2375-6288
E-Mail sales@sick.com.tw

Türkiye

Phone +90 (216) 528 50 00
E-Mail info@sick.com.tr

United Arab Emirates

Phone +971 (0) 4 8865 878
E-Mail info@sick.ae

USA/México

Phone +1(952) 941-6780
1 800-325-7425 – tollfree
E-Mail info@sickusa.com

More representatives and agencies
at www.sick.com