

Price* : 309.60 GBP



Main

Range of product	OsiSense XCC
Encoder type	Incremental encoder
Encoder name	XCC
Product specific application	-
Diameter	58 mm
Shaft diameter	10 mm
Shaft type	Solid shaft
Resolution	100 points
Output stage	Type X
Type of output stage	Driver 5V, RS422
Electrical connection	1 male connector M23 radial 12 pins
[Us] rated supply voltage	4.75...30 V DC
Enclosure material	Zamak

Complementary

Residual ripple	500 mV
Maximum revolution speed	9000 rpm
Shaft moment of inertia	10 g.cm ²
Torque value	0.004 N.m
Maximum load	10 daN radial 5 daN axial
Output frequency	300 kHz
Number of channels	3
Current consumption	0...75 mA no-load
Protection type	Reverse polarity protection Short-circuit protection
Maximum output current	40 mA
Output level	Low level: 0.5 V maximum 20 mA High level: 4.5 V minimum 20 mA
Surge withstand	1 kV, level 2 conforming to IEC 61000-4-5
Base material	Aluminium

Shaft material	Stainless steel
Type of ball bearings	6000ZZ1
Product weight	0.465 kg

Environment

Marking	CE
Ambient air temperature for operation	-30...100 °C
Ambient air temperature for storage	-30...85 °C
IP degree of protection	IP65 conforming to IEC 60529
Vibration resistance	10 gn (f= 55...2000 Hz) conforming to IEC 60068-2-6
Shock resistance	30 gn for 11 ms conforming to IEC 60068-2-27
Resistance to electrostatic discharge	4 kV (contact discharge) level 3 conforming to IEC 61000-4-2 8 kV (air discharge) level 3 conforming to IEC 61000-4-2
Resistance to electromagnetic fields	10 V/m level 3 conforming to IEC 61000-4-3
Resistance to fast transients	1 kV signal ports level 3 conforming to IEC 61000-4-4 2 kV power ports level 3 conforming to IEC 61000-4-4

Offer Sustainability

RECh free of SVHC	Yes
EU RoHS Directive	Pro-active compliance (Product out of EU RoHS legal scope) EU RoHS Declaration
Toxic heavy metal free	Yes
Mercury free	Yes
RoHS exemption information	Yes

Contractual warranty

Warranty	18 months
----------	-----------

Dimensions

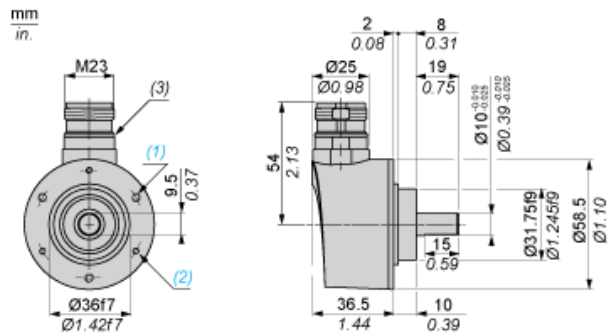

- (1) 3 M4 holes at 120° on 48 PCD, depth: 8 mm
- (2) 3 M3 holes at 120° on 48 PCD, depth: 8 mm
- (3) Nitrile seal

Wiring Diagram

Type X Output Stage

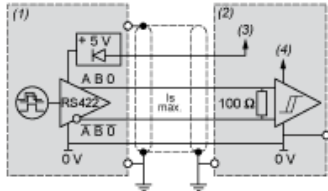

- (1) Encoder
- (2) Processing
- (3) Supply 4.75 V/30 V
- (4) Supply 5 V

Wiring Diagram

M23, 12-pin Connector Connections

Male Connector on Encoder



Pin number	1	2	3	4	5	6	7	8	9	10	11	12
Signal Supply	A ⁻	+V	0	0 ⁻	B	B ⁻	R	A	R	0 V	0 V	+V

R = reserved, do not connect