

Price* : 327.02 GBP



Main

Range of product	OsiSense XCC
Encoder type	Incremental encoder
Encoder name	XCC
Product specific application	-
Diameter	58 mm
Shaft diameter	14 mm
Shaft type	Through shaft
Resolution	100 points
Output stage	Type Y
Type of output stage	Driver push-pull
Electrical connection	1 male connector M23 radial 12 pins
[Us] rated supply voltage	5...30 V DC
Enclosure material	Zamak

Complementary

Shaft tolerance	H7
Residual ripple	500 mV
Maximum revolution speed	6000 rpm
Shaft moment of inertia	22 g.cm ²
Torque value	0.006 N.m
Maximum load	2 daN axial 5 daN radial
Output frequency	300 kHz
Number of channels	3
Current consumption	0...75 mA no-load
Protection type	Reverse polarity protection Short-circuit protection
Maximum output current	40 mA
Output level	Low level: 0.5 V maximum 20 mA High level: V supply - 2.5 V minimum 20 mA
Surge withstand	1 kV, level 2 conforming to IEC 61000-4-5

Disclaimer: This documentation is not intended as a substitute for and is not to be used for determining suitability or reliability of these products for specific user applications

Base material	Aluminium
Shaft material	Stainless steel
Type of ball bearings	6803ZZ
Product weight	0.435 kg

Environment

Marking	CE
Ambient air temperature for operation	-30...100 °C
Ambient air temperature for storage	-30...85 °C
IP degree of protection	IP65 conforming to IEC 60529
Vibration resistance	10 gn (f= 55...2000 Hz) conforming to IEC 60068-2-6
Shock resistance	30 gn for 11 ms conforming to IEC 60068-2-27
Resistance to electrostatic discharge	4 kV (contact discharge) level 3 conforming to IEC 61000-4-2 8 kV (air discharge) level 3 conforming to IEC 61000-4-2
Resistance to electromagnetic fields	10 V/m level 3 conforming to IEC 61000-4-3
Resistance to fast transients	1 kV signal ports level 3 conforming to IEC 61000-4-4 2 kV power ports level 3 conforming to IEC 61000-4-4

Offer Sustainability

REACH free of SVHC	Yes
EU RoHS Directive	Pro-active compliance (Product out of EU RoHS legal scope) EU RoHS Declaration
Toxic heavy metal free	Yes
Mercury free	Yes
RoHS exemption information	Yes

Contractual warranty

Warranty	18 months
----------	-----------

Dimensions

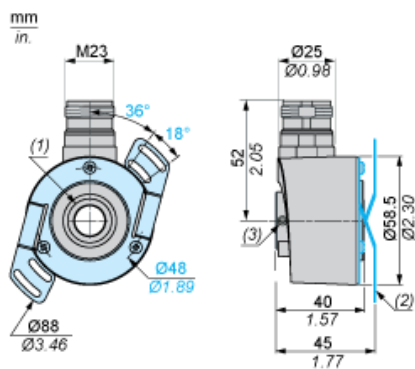

- (1) Through shaft, Ø 14 (H7)
- (2) Flexible mounting kit, 1 x XCCRF5N mounted
- (3) 2 HC M4 x 4 locking screws

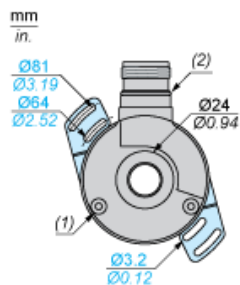

- (1) Hole for M3 x 6 self-threading screw
- (2) Nitrile seal

Wiring Diagram

Type Y Output Stage

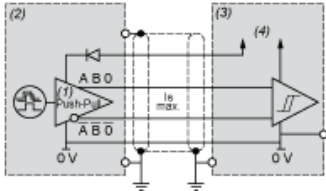

- (1) RS 422 compatible on 5 V supply
- (2) Encoder
- (3) Processing
- (4) Supply 5 V/30 V

Wiring Diagram

M23, 12-pin Connector Connections

Male Connector on Encoder



Pin number	1	2	3	4	5	6	7	8	9	10	11	12
Signal Supply	A ⁻	+V	0	0 ⁻	B	B ⁻	R	A	R	0 V	0 V	+V

R = reserved, do not connect