



Main

Range of product	OsiSense XCC
Encoder type	Incremental encoder
Encoder name	XCC
Product specific application	-
Diameter	90 mm
Shaft diameter	30 mm
Shaft type	Through shaft
Resolution	500 points
Output stage	Type K
Type of output stage	Driver push-pull
Electrical connection	1 male connector M23 radial 12 pins
[Us] rated supply voltage	11...30 V DC
Enclosure material	Zamak

Complementary

Shaft tolerance	H7
Residual ripple	500 mV
Maximum revolution speed	3600 rpm
Shaft moment of inertia	500 g.cm ²
Torque value	0.025 N.m
Maximum load	5 daN axial 8 daN radial
Output frequency	100 kHz
Number of channels	3
Current consumption	0...75 mA no-load
Protection type	Reverse polarity protection Short-circuit protection
Maximum output current	40 mA
Output level	Low level: 1.5 V maximum 20 mA High level: V supply - 3 V minimum 20 mA
Surge withstand	1 kV, level 2 conforming to IEC 61000-4-5

Base material	Aluminium
Shaft material	Stainless steel
Type of ball bearings	6807
Product weight	0.96 kg

Environment

Marking	CE
Ambient air temperature for operation	-20...80 °C
Ambient air temperature for storage	-30...85 °C
IP degree of protection	IP65 conforming to IEC 60529
Vibration resistance	10 gn (f= 10...1000 Hz) conforming to IEC 60068-2-6
Shock resistance	30 gn for 11 ms conforming to IEC 60068-2-27
Resistance to electrostatic discharge	4 kV (contact discharge) level 3 conforming to IEC 61000-4-2 8 kV (air discharge) level 3 conforming to IEC 61000-4-2
Resistance to electromagnetic fields	10 V/m level 3 conforming to IEC 61000-4-3
Resistance to fast transients	1 kV signal ports level 3 conforming to IEC 61000-4-4 2 kV power ports level 3 conforming to IEC 61000-4-4

Offer Sustainability

REACH free of SVHC	Yes
EU RoHS Directive	Pro-active compliance (Product out of EU RoHS legal scope) EU RoHS Declaration
Toxic heavy metal free	Yes
Mercury free	Yes
RoHS exemption information	Yes

Contractual warranty

Warranty	18 months
----------	-----------

Dimensions

mm
in.

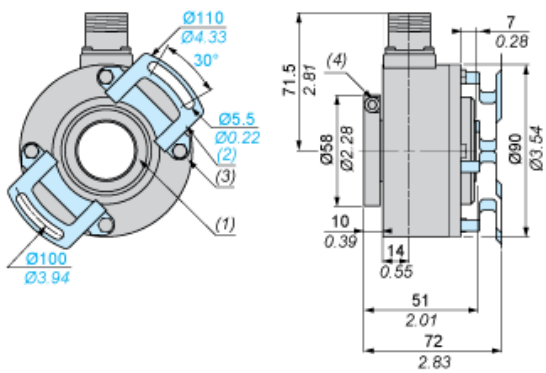

- (1) Through shaft, $\varnothing 30$ (H7)
- (2) Anti-rotation device, 1 x XCCRF9N, mounted
- (3) 4 M5 x 6 on 78 PCD
- (4) 1 CHC M5 x 12 stainless steel A2 locking screw

Wiring Diagram

Type K Output Stage

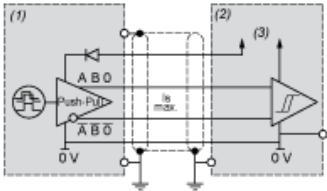

- (1) Encoder
- (2) Processing
- (3) Supply 11 V/30 V

Wiring Diagram

M23, 12-pin Connector Connections

Male Connector on Encoder



Pin number	1	2	3	4	5	6	7	8	9	10	11	12
Signal Supply	A ⁻	+V	0	0 ⁻	B	B ⁻	R	A	R	0 V	0 V	+V

R = reserved, do not connect