



### Main

Range of product	OsiSense XC
Series name	Standard format
Product or component type	Limit switch
Device short name	XCKJ
Sensor design	-
Body type	Fixed
Head type	Rotary head
Material	Metal
Body material	Zamak
Head material	Zamak
Fixing mode	By the body
Movement of operating head	Rotary
Type of operator	Spring return roller lever metal variable length
Type of approach	Lateral approach, 1 or 2 programmable direction
Cable entry	1 entry tapped for Pg 13.5 cable gland, cable outer diameter: 9...12 mm
Number of poles	2
Contacts type and composition	1 NC + 1 NO
Contact operation	Snap action

### Complementary

Switch actuation	By 30° cam
Electrical connection	Screw-clamp terminals, clamping capacity: 1 x 0.34...2 x 1.5 mm <sup>2</sup>
Contacts insulation form	Zb
Number of steps	1
Positive opening	Without
Minimum torque for tripping	0.25 N.m
Maximum actuation speed	1.5 m/s

[Ie] rated operational current	3 A at 240 V, AC-15, A300 conforming to EN/IEC 60947-5-1 appendix A 0.27 A at 250 V, DC-13, Q300 conforming to EN/IEC 60947-5-1 appendix A
[Ithe] conventional enclosed thermal current	10 A
[Ui] rated insulation voltage	300 V conforming to UL 508 500 V (pollution degree 3) conforming to IEC 60947-1 300 V conforming to CSA C22.2 No 14
Maximum resistance across terminals	25 MOhm conforming to IEC 60255-7 category 3
[Uimp] rated impulse withstand voltage	IEC 60664 6 kV IEC 60947-1 6 kV
Short-circuit protection	10 A cartridge fuse, type gG
Electrical durability	5000000 cycles, DC-13, inductive load type, 120 V, 4 W, operating rate <60 cyc/mn, load factor: 0.5 conforming to IEC 60947-5-1 appendix C 5000000 cycles, DC-13, inductive load type, 24 V, 10 W, operating rate <60 cyc/mn, load factor: 0.5 conforming to IEC 60947-5-1 appendix C 5000000 cycles, DC-13, inductive load type, 48 V, 7 W, operating rate <60 cyc/mn, load factor: 0.5 conforming to IEC 60947-5-1 appendix C
Mechanical durability	30000000 cycles
Width	40 mm
Height	77 mm
Depth	44 mm
Product weight	0.485 kg
Terminals description ISO n°1	(13-14)NO (21-22)NC

## Environment

Shock resistance	50 gn for 11 ms conforming to IEC 60068-2-27
Vibration resistance	25 gn (f= 10...500 Hz) conforming to IEC 60068-2-6
IP degree of protection	IP66 conforming to IEC 60529
IK degree of protection	IK07 conforming to EN 50102
Overvoltage category	Class I conforming to IEC 61140 Class I conforming to NF C 20-030
Ambient air temperature for operation	-25...70 °C
Ambient air temperature for storage	-40...70 °C
Protective treatment	TC
Product certifications	CCC UL CSA
Standards	UL 508 CENELEC EN 50041 EN 60204-1 IEC 60204-1 CSA C22.2 No 14 EN 60947-5-1 IEC 60947-5-1

## Offer Sustainability

Sustainable offer status	Green Premium product
EU RoHS Directive	Pro-active compliance (Product out of EU RoHS legal scope) <a href="#">EU RoHS Declaration</a>
Mercury free	Yes
RoHS exemption information	<a href="#">Yes</a>
Environmental Disclosure	<a href="#">Product Environmental Profile</a>
Circularity Profile	No need of specific recycling operations

## Contractual warranty

Warranty	18 months
----------	-----------



---

Mounting with Cable Entry

---

Position of Cable Gland



- (1) Recommended
- (2) To be avoided

---

Mounting with Rotary Heads and Levers

---

Type of Cam

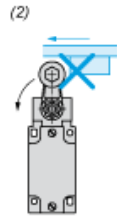
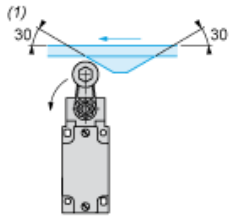

- (1) Recommended
- (2) To be avoided

Setting-up with Lever Head

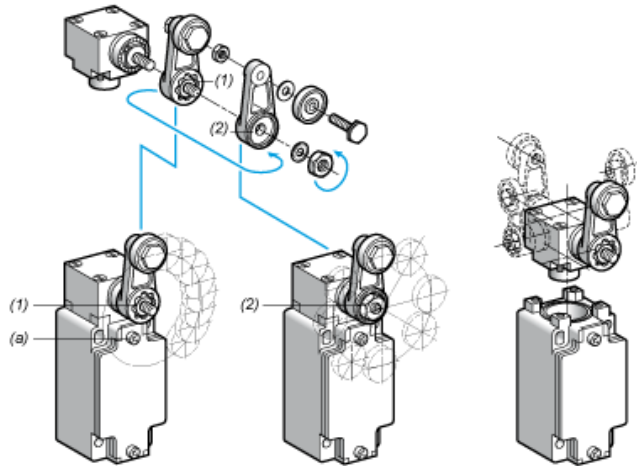

- (1) 5° steps throughout 360° / Tightening torque (Min : 1) (Max : 1.5)
- (2) 45° steps throughout 360° / Tightening torque (Min : 1) (Max : 1.5)
- (a) Tightening torque (Min : 1) (Max : 1.5)

---

Setting-up with Head ZCKE05

---

Direction of Actuation Programming

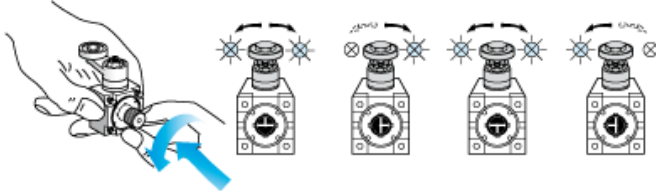

---

Wiring Diagram

---

2-pole NC + NO Snap Action

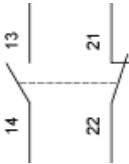

---

Characteristics of Actuation

---

Switch Actuation by 30° Cam

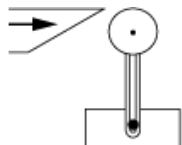

Functionnal Diagram

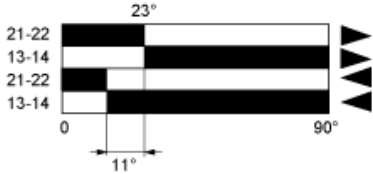

- (1) Closed
- (2) Open
- (3) Tripping
- (4) Resetting

(1) Closed  
(2) Open  
(3) Tripping  
(4) Resetting