

Main

Accessory / separate part type	Display
Display type	Digital display
Operating position	Any position
Product compatibility	XMLP analogue pressure sensors, connector type: EN 175301-803-A (ex DIN43650) XMLE analogue pressure sensors 0...10 bar, connector type: EN 175301-803-A (ex DIN43650)

Complementary

Product weight	0.1 kg
Height	66 mm
Depth	40 mm
Width	92 mm

Environment

Protective treatment	TC
IP degree of protection	IP65 conforming to EN/IEC 60529
Vibration resistance	5 gn (f = 25...200 Hz) 35 gn (f = 60...2000 Hz)
Ambient air temperature for operation	-15...80 °C
Standards	CE EN 50081 EN 50082
Product certifications	CSA UL

Offer Sustainability

Sustainable offer status	Not Green Premium product
RoHS (date code: YYWW)	Compliant - since 0627 - Schneider Electric declaration of conformity
REACH	Reference not containing SVHC above the threshold

Dimensions

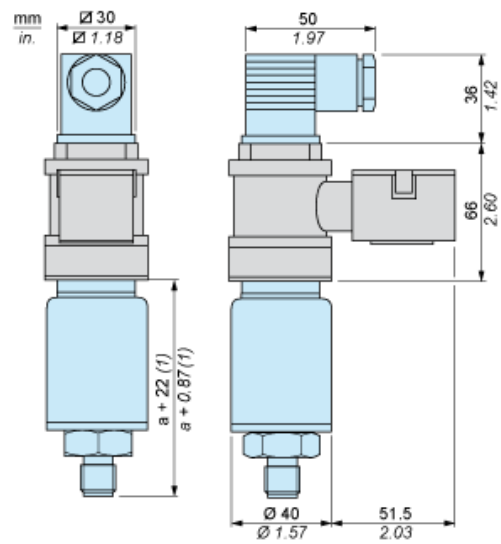

(1) a = 65