



Main

Range of product	OsiSense XM
Product or component type	Electronic pressure sensors
Pressure sensor type	Pressure transmitter
Pressure sensor name	XMLG
Pressure sensor size	16 bar
Fluid connection type	G 1/4A (male) conforming to DIN 3852-E
Controlled fluid	Fresh water (0...125 °C) Hydraulic oil (-15...125 °C) Corrosive fluid (-15...125 °C) Air (-15...125 °C)
Type of output signal	Analogue
Analogue output function	0...10 V, 3 wires
Electrical connection	3 pins 1 male connector M12
[Us] rated supply voltage	24 V DC, voltage limits: 11.4...33 V
Quantity per set	Set of 1
Type of packing	Individual
Diameter	22.8 mm

Complementary

Pressure setting range	0...16 bar
Maximum permissible accidental pressure	36 bar
Destruction pressure	40 bar
Local display	Without
Electrical circuit type	Control circuit
Current consumption	< 20 mA
Materials in contact with fluid	Ceramic FPM (Viton) Stainless steel type AISI 303
Operating position	Any position
Protection type	Load short-circuit Reverse polarity
Surge withstand	500 kV (12 Ohm) conforming to EN/IEC 61000-4-5 1 kV (42 Ohm) conforming to EN/IEC 61000-4-5
[Uimp] rated impulse withstand voltage	0.5 kV
Response time on output	< 2 ms
Drift of the sensitivity	+/- 0.015 % of measuring range/°C
Drift of the zero point	+/- 0.015 % of measuring range/°C
Measurement accuracy	+/- 0.3 % of the measuring range
Repeat accuracy	+/- 0.1 % of the measuring range
Mechanical durability	>= 10000000 cycles
Product weight	0.095 kg
Height	58.1 mm

Environment

Standards	CE EN/IEC 61326-2-3
Product certifications	UL 508 CSA C22.2 No 14 EAC
Protective treatment	TC
Ambient air temperature for operation	-15...85 °C
Ambient air temperature for storage	-40...85 °C
Vibration resistance	20 gn (f = 9...2000 Hz) conforming to EN/IEC 60028-2-6
Shock resistance	25 gn for 11 ms conforming to EN/IEC 60068-2-27
Resistance to electrostatic discharge	8 kV (on contact) conforming to EN/IEC 61000-4-2 15 kV (in air) conforming to EN/IEC 61000-4-2
Resistance to electromagnetic fields	200 V/m (80...1000 Hz) conforming to EN/IEC 61000-4-3
Resistance to fast transients	4 kV conforming to EN/IEC 61000-4-4
Resistance to conducted disturbances, induced by radio frequency fields	30 V (0.15...80 Hz) conforming to EN/IEC 61000-4-6
Resistance to magnetic fields	30 A/m (50 Hz) conforming to EN/IEC 61000-4-8
IP degree of protection	IP67 conforming to EN/IEC 60529 IP66 conforming to EN/IEC 60529
NEMA degree of protection	NEMA 4

Offer Sustainability

Sustainable offer status	Not Green Premium product
RoHS (date code: YYWW)	Compliant - since 0627 - Schneider Electric declaration of conformity
REACH	Reference not containing SVHC above the threshold

Dimensions

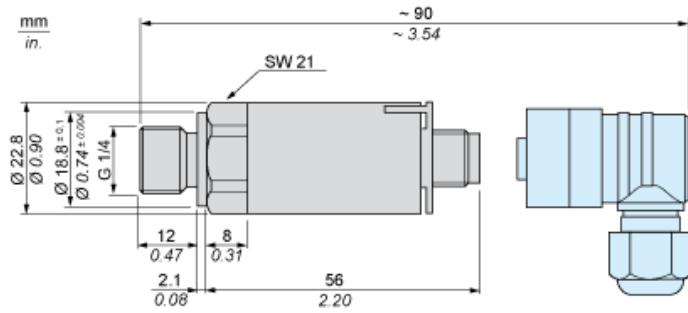

Wiring Diagram

3-Wire Technique (0-10 V)

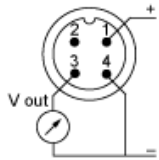

Output Curves

