

# XMLG250D21

pressure sensor XMLG - 0..250 bar - G 1/4A  
(male) - 24 V - 4..20 mA



## Main

Range of product	OsiSense XM
Product or component type	Electronic pressure sensors
Pressure sensor type	Pressure transmitter
Pressure sensor name	XMLG
Pressure sensor size	250 bar
Fluid connection type	G 1/4A (male) conforming to DIN 3852-E
Controlled fluid	Fresh water (0...125 °C) Hydraulic oil (-15...125 °C) Corrosive fluid (-15...125 °C) Air (-15...125 °C)
Type of output signal	Analogue
Analogue output function	4...20 mA, 2 wires
Electrical connection	3 pins 1 male connector M12
[Us] rated supply voltage	24 V DC, voltage limits: 8...33 V 12 V DC, voltage limits: 8...33 V
Quantity per set	Set of 1
Type of packing	Individual
Diameter	22.8 mm

## Complementary

Pressure setting range	0...250 bar
Maximum permissible accidental pressure	560 bar
Destruction pressure	625 bar
Local display	Without
Electrical circuit type	Control circuit
Current consumption	< 20 mA
Materials in contact with fluid	Ceramic FPM (Viton) PPS Stainless steel type AISI 303
Operating position	Any position
Protection type	Load short-circuit Reverse polarity
Surge withstand	500 kV (12 Ohm) conforming to EN/IEC 61000-4-5 1 kV (42 Ohm) conforming to EN/IEC 61000-4-5
[Uimp] rated impulse withstand voltage	0.5 kV
Response time on output	< 2 ms
Drift of the sensitivity	+/- 0.015 % of measuring range/°C
Drift of the zero point	+/- 0.015 % of measuring range/°C
Measurement accuracy	+/- 0.3 % of the measuring range
Repeat accuracy	+/- 0.1 % of the measuring range
Mechanical durability	>= 10000000 cycles
Product weight	0.095 kg
Height	58.1 mm

The information provided in this documentation contains general descriptions and/or technical characteristics of the performance of the products contained herein. This documentation is not intended as a substitute for and is not to be used for determining suitability or reliability of these products for specific user applications. It is the duty of any such user or integrator to perform the appropriate and complete risk analysis, evaluation and testing of the products with respect to the relevant specific application or use thereof. Neither Schneider Electric Industries SAS nor any of its affiliates or subsidiaries shall be responsible or liable for misuse of the information contained herein.

## Environment

Standards	CE EN/IEC 61326-2-3
Product certifications	UL 508 CSA C22.2 No 14 EAC
Protective treatment	TC
Ambient air temperature for operation	-15...85 °C
Ambient air temperature for storage	-40...85 °C
Vibration resistance	20 gn (f = 9...2000 Hz) conforming to EN/IEC 60028-2-6
Shock resistance	25 gn for 11 ms conforming to EN/IEC 60068-2-27
Resistance to electrostatic discharge	8 kV (on contact) conforming to EN/IEC 61000-4-2 15 kV (in air) conforming to EN/IEC 61000-4-2
Resistance to electromagnetic fields	200 V/m (80...1000 Hz) conforming to EN/IEC 61000-4-3
Resistance to fast transients	4 kV conforming to EN/IEC 61000-4-4
Resistance to conducted disturbances, induced by radio frequency fields	30 V (0.15...80 Hz) conforming to EN/IEC 61000-4-6
Resistance to magnetic fields	30 A/m (50 Hz) conforming to EN/IEC 61000-4-8
IP degree of protection	IP67 conforming to EN/IEC 60529 IP66 conforming to EN/IEC 60529
NEMA degree of protection	NEMA 4

## Offer Sustainability

Sustainable offer status	Not Green Premium product
RoHS (date code: YYWW)	Compliant - since 0627 - <a href="#">Schneider Electric declaration of conformity</a>
REACH	Reference not containing SVHC above the threshold

Dimensions

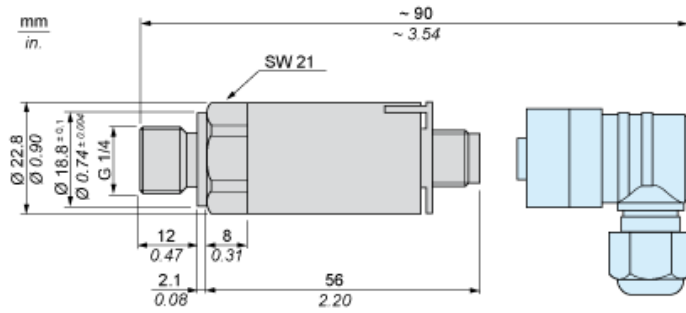

---

## Wiring Diagram

---

### 2-Wire Technique (4-20 mA)



---

Output Curves

---

