

XMLK300P2D23

pressure sensor XMLK - 0..300psi - 1/4NPT - 4..20mA - M12 - set of 1



Main

Range of product	OsiSense XM
Product or component type	Electronic pressure sensors
Pressure sensor type	Pressure transmitter
Pressure sensor name	XMLK
Electrical circuit type	Control circuit
Pressure sensor size	300 psi
Local display	Without
Controlled fluid	Fresh water 0...80 °C Air 0...80 °C
Fluid connection type	1/4" - 18 NPT (male)
Electrical connection	1 male connector M12 4 pins
[Us] rated supply voltage	24 V DC SELV, voltage limits: 8...33 V
Current consumption	< 20 mA
Type of output signal	Analogue
Analogue output function	4...20 mA, 2-wire
Quantity per set	Set of 1
Type of packing	Individual

Complementary

Pressure setting range	0...300 psi
Maximum permissible accidental pressure	600 psi
Destruction pressure	900 psi
Materials in contact with fluid	Ceramic Nitrile (NBR) Stainless steel type AISI 303
Operating position	Any position
Protection type	Load short-circuit Reverse polarity
Electromagnetic compatibility	Immunity to magnetic fields conforming to EN/IEC 61000-4-8 - test level 30 A/m (f = 50 Hz) Radiated RF fields conforming to EN/IEC 61000-4-6 - test level 10 V (f = 0.15...80 MHz) 1.2/50 µs shock waves immunity test conforming to EN/IEC 61000-4-5 - test level 500 V 12 Ohm, 1 kV 42 Ohm Electrical fast transient/burst immunity test conforming to EN/IEC 61000-4-4 - test level 2 kV Susceptibility to electromagnetic fields conforming to EN/IEC 61000-4-3 - test level 10 V/m (f = 80...1000 MHz) Electrostatic discharge immunity test conforming to EN/IEC 61000-4-2 - test level 8 kV air, 6 kV contact
[Uimp] rated impulse withstand voltage	0.5 kV
Response time on output	< 5 ms
Drift of the sensitivity	+/- 0.04 % of measuring range/°K
Drift of the zero point	+/- 0.03 % of measuring range/°K
Measurement accuracy	+/- 1 % of the measuring range
Repeat accuracy	+/- 0.3 % of the measuring range
Mechanical durability	>= 10000000 cycles
Product weight	0.11 kg
Diameter	36 mm
Length	65.5 mm

Environment

Standards	CE EN/IEC 61326-2-3
Product certifications	UL 508 RCM CSA C22.2 No 14 EAC
Protective treatment	TC
Ambient air temperature for operation	0...80 °C
Ambient air temperature for storage	-25...80 °C
Vibration resistance	20 gn (f = 9...2000 Hz) conforming to EN/IEC 60068-2-6
Shock resistance	25 gn for 11 ms conforming to EN/IEC 60068-2-27
IP degree of protection	IP65 conforming to EN/IEC 60529
NEMA degree of protection	NEMA 4

Offer Sustainability

Sustainable offer status	Not Green Premium product
RoHS (date code: YYWW)	Compliant - since 1001 - Schneider Electric declaration of conformity
REACH	Reference not containing SVHC above the threshold

Dimensions

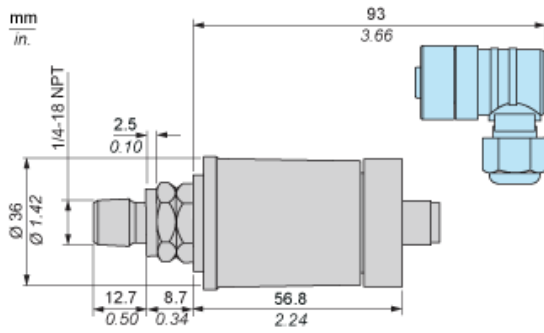

Wiring Diagram

2-Wire Technique (4-20 mA)

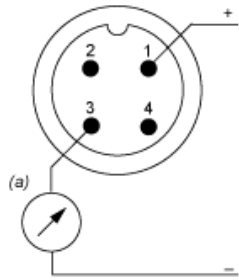

(a) I out

Output Curves

