



Price\* : 57.66 GBP



## Main

Range of product	OsiSense XS
Series name	General purpose
Sensor type	Inductive proximity sensor
Device application	-
Sensor name	XS2
Sensor design	Cylindrical M18
Size	49 mm
Body type	Fixed
Detector flush mounting acceptance	Non flush mountable
Material	Metal
Type of output signal	Discrete
Wiring technique	4-wire
[Sn] nominal sensing distance	8 mm
Discrete output function	1 NO + 1 NC
Output circuit type	DC
Discrete output type	NPN
Electrical connection	Male connector M12, 4 pins
[Us] rated supply voltage	12...24 V DC with reverse polarity protection
Switching capacity in mA	<= 200 mA with overload and short-circuit protection
IP degree of protection	IP67 conforming to IEC 60529

## Complementary

Thread type	M18 x 1
Detection face	Frontal
Front material	PPS
Enclosure material	Nickel plated brass

Operating zone	0...6.4 mm
Differential travel	1...15% of Sr
Status LED	Output state: 1 LED (yellow)
Supply voltage limits	10...36 V DC
Switching frequency	<= 2000 Hz
Maximum voltage drop	<2 V (closed)
Current consumption	0...10 mA no-load
Maximum delay first up	5 ms
Maximum delay response	0.15 ms
Maximum delay recovery	0.35 ms
Marking	CE
Threaded length	20 mm
Height	18 mm
Length	49 mm
Product weight	0.04 kg

## Environment

Product certifications	CSA UL
Ambient air temperature for operation	-25...70 °C
Ambient air temperature for storage	-40...85 °C
Vibration resistance	25 gn amplitude = +/- 2 mm (f = 10...55 Hz) conforming to IEC 60068-2-6
Shock resistance	50 gn for 11 ms conforming to IEC 60068-2-27

## Offer Sustainability

Sustainable offer status	Green Premium product
EU RoHS Directive	Pro-active compliance (Product out of EU RoHS legal scope) <a href="#">EU RoHS Declaration</a>
Mercury free	Yes
RoHS exemption information	<a href="#">Yes</a>
Environmental Disclosure	<a href="#">Product Environmental Profile</a>
Circularity Profile	<a href="#">End of Life Information</a>

## Contractual warranty

Warranty	18 months
----------	-----------

Dimensions

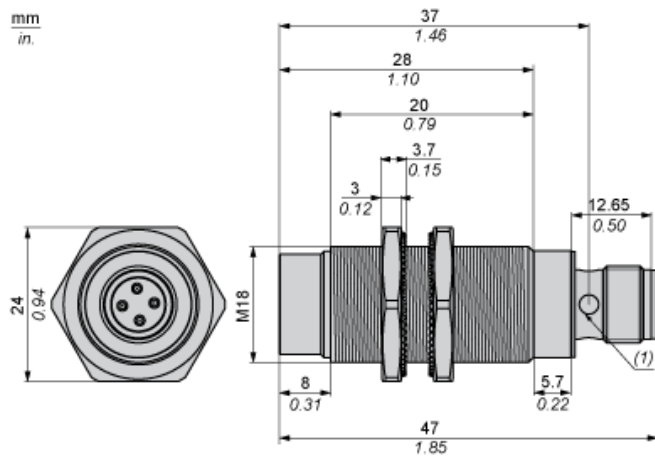

(1) LED

---

Minimum Mounting Distances

---

Side by side



$e (1) \geq 32 \text{ mm}/1.26 \text{ in.}$

Face to face



$e (2) \geq 96 \text{ mm}/3.78 \text{ in.}$

Facing a metal object



$e (3) \geq 24 \text{ mm}/0.94 \text{ in.}$

Mounted in a metal support



$d \geq 56 \text{ mm}/2.20 \text{ in.}$

$h \geq 16 \text{ mm}/0.63 \text{ in.}$

---

Wiring Schemes

---

M12 connector



NPN 4-wire

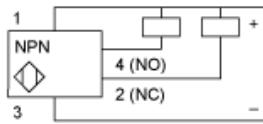

Performance Curves

Standard Steel Target : 24x24x1 mm



- (1) Pick-up points
- (2) Drop-out points (object approaching from the side)
- (y) Sensing distance in mm