



Price* : 30.04 GBP



Main

Range of product	OsiSense XS
Series name	General purpose
Sensor type	Inductive proximity sensor
Device application	-
Sensor name	XS7
Sensor design	Flat form 26 x 26 x 13
Size	13 mm
Body type	Fixed
Detector flush mounting acceptance	Flush mountable
Material	Plastic
Enclosure material	PBT
Type of output signal	Discrete
Wiring technique	3-wire
Discrete output function	1 NO
Output circuit type	DC
Discrete output type	PNP
Electrical connection	cable
Cable length	5 m
[Us] rated supply voltage	12...24 V DC with reverse polarity protection
Switching capacity in mA	<= 100 mA DC with overload and short-circuit protection
IP degree of protection	IP68 double insulation conforming to IEC 60529

Complementary

Detection face	Frontal
Front material	PBT
Operating zone	0...8 mm

Differential travel	1...15% of Sr
Cable composition	3 x 0.34 mm ²
Wire insulation material	PvR
Status LED	Output state: 1 LED (yellow)
Supply voltage limits	10...36 V DC
Switching frequency	<= 1000 Hz
Maximum voltage drop	<2 V (closed)
Current consumption	<= 10 mA no-load
Maximum delay first up	10 ms
Maximum delay response	2 ms
Maximum delay recovery	6 ms
Marking	CE
Depth	13 mm
Height	26 mm
Width	26 mm
Product weight	0.195 kg

Environment

Product certifications	C-Tick UL CSA
Ambient air temperature for operation	-25...70 °C
Ambient air temperature for storage	-40...85 °C
Vibration resistance	25 gn amplitude = +/- 2 mm (f = 10...55 Hz) conforming to IEC 60068-2-6
Shock resistance	50 gn for 11 ms conforming to IEC 60068-2-27

Offer Sustainability

Sustainable offer status	Green Premium product
EU RoHS Directive	Pro-active compliance (Product out of EU RoHS legal scope) EU RoHS Declaration
Mercury free	Yes
RoHS exemption information	Yes
Environmental Disclosure	Product Environmental Profile
Circularity Profile	No need of specific recycling operations End of Life Information

Contractual warranty

Warranty	18 months
----------	-----------

Dimensions

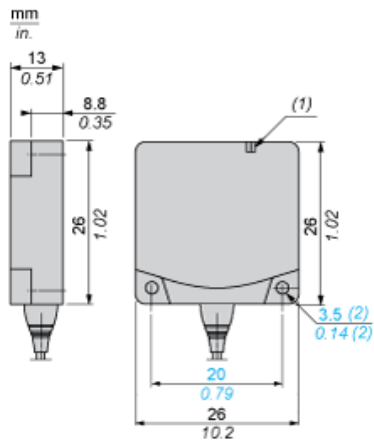

- (1) LED
- (2) For CHC type screws

Setting-up

Minimum Mounting Distances (mm)

Side by Side



$$e (1) \geq 30$$

Face to Face



$$e (2) \geq 72$$

Facing a Metal Object

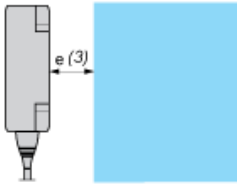

$$e (3) \geq 30$$

Wiring Schemes

PNP

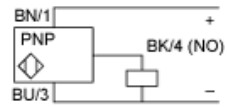

BU : Blue
BN : Brown
BK : Black