



Price* : 121.76 GBP



Main

Range of product	OsiSense XS
Series name	General purpose
Sensor type	Inductive proximity sensor
Device application	-
Sensor name	XS8
Sensor design	Flat form 80 x 80 x 26
Size	26 mm
Body type	Fixed
Detector flush mounting acceptance	Non flush mountable
Material	Plastic
Enclosure material	PBT
Type of output signal	Discrete
Wiring technique	3-wire
[Sn] nominal sensing distance	40 mm flush mountable 60 mm non flush mountable
Discrete output function	1 NO
Output circuit type	DC
Discrete output type	PNP
Electrical connection	Cable
Cable length	10 m
[Us] rated supply voltage	12...24 V DC with reverse polarity protection
Switching capacity in mA	<= 200 mA DC with overload and short-circuit protection
IP degree of protection	IP68 double insulation conforming to IEC 60529

Complementary

Detection face	Frontal
Front material	PBT

Fine adjustment zone	20...40 mm flush mountable 20...60 mm non flush mountable
Differential travel	1...15% of Sr
Cable composition	3 x 0.34 mm ²
Wire insulation material	PvR
Supply voltage limits	10...36 V DC
Maximum residual current	1.5 mA open state
Switching frequency	<= 150 Hz
Maximum voltage drop	<2 V (closed)
Current consumption	<= 10 mA no-load
Maximum delay first up	10 ms
Maximum delay response	0.3 ms
Maximum delay recovery	6 ms
Marking	CE
Depth	26 mm
Height	80 mm
Width	80 mm
Product weight	0.71 kg

Environment

Product certifications	CSA UL
Ambient air temperature for operation	-25...70 °C
Ambient air temperature for storage	-40...85 °C
Vibration resistance	25 gn amplitude = +/- 2 mm (f = 10...55 Hz) conforming to IEC 60068-2-6
Shock resistance	50 gn for 11 ms conforming to IEC 60068-2-27

Offer Sustainability

Sustainable offer status	Green Premium product
EU RoHS Directive	Pro-active compliance (Product out of EU RoHS legal scope) EU RoHS Declaration
Mercury free	Yes
RoHS exemption information	Yes
Environmental Disclosure	Product Environmental Profile
Circularity Profile	No need of specific recycling operations End of Life Information

Contractual warranty

Warranty	18 months
----------	-----------

Dimensions

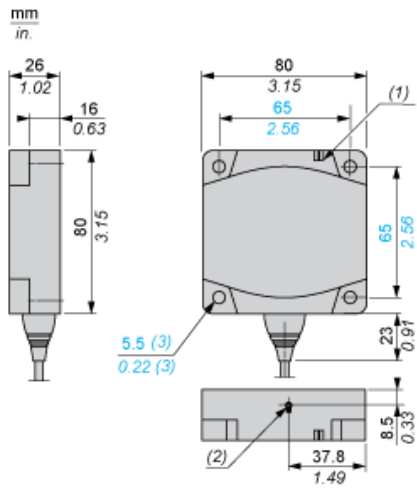

- (1) LED
- (2) Teach mode button
- (3) For CHC type screws

Setting-up

Minimum Mounting Distances (mm)

Side by Side



Face to Face



Facing a Metal Object



	e (1)	e (2)	e (3)
Flush mounted	200	400	40
Not flush mounted	600	not recommended	

Wiring Schemes

PNP

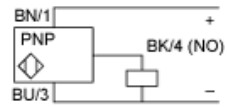

BU : Blue
BN : Brown
BK : Black