

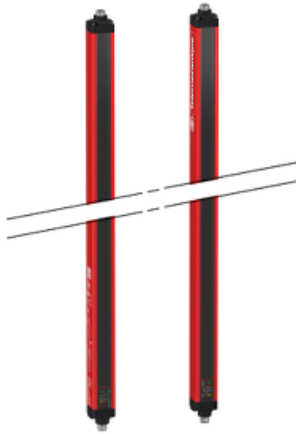

Price\* : 1,099.77 GBP



### Main

Range of product	Preventa Safety detection
Product or component type	Safety light curtain type 4
Device short name	XUSL4E
Output type	2 safety outputs OSSD solid-state PNP (arc suppression)
[Sn] nominal sensing distance	0...12 m by cabling 0...4 m by cabling
[Hp] Height protected	510 mm
Number of beams	2
Space between beams	500 mm
Type of start / restart	Automatic Manual
External Device Monitoring (EDM)	Selected by wiring

### Complementary

Detection system	Transmitter-receiver system
Kit composition	adjustable mounting bracket(s) 1 receiver(s) 1 transmitter(s) 1 user guide with certificate of conformity on CD-ROM
[EAA] effective aperture angle	2.5 ° at 3 m
Emission	IR LED 950 nm
[Us] rated supply voltage	24 V DC +/- 20 %
Supply	Power supply conforming to IEC 61496-1 Power supply conforming to IEC 60204-1
[Ie] rated operational current	2 A
Current consumption	42 mA no-load transmitter 83 mA no-load receiver 42 mA transmitter 900 mA with maximum load receiver

Output current limits	0.4 A for safety outputs OSSD
Output voltage	24 V
Output circuit type	DC
Maximum voltage drop	<0.5 V
Local signalling	1 multi-colour LED transmitter 2 dual colour LEDs receiver
Electrical connection	1 male connector M12 5 pins transmitter 1 male connector M12 8 pins receiver
Function available	Test Muting through external safety module XPSLCMUT1160 LED display of operating modes and faults
Marking	CE
Material	Aluminium: casing Polycarbonate: front panel Polypropylene: end caps
Housing colour	Red RAL 3000
Fixing mode	By fixing brackets
Product weight	1.1 kg
Offer type	Standard distance
Topology	Daisy chain slave2

## Environment

Directives	2002/95/EC - RoHS directive 98/37/EEC - machinery 2002/96/EC - WEEE directive 89/336/EEC - electromagnetic compatibility 89/655/EEC - work equipment
Product certifications	CULus TÜV CE
Safety level (correctly wired)	Type 4 conforming to IEC 61496-1 SIL 3 conforming to IEC 61508 SILCL 3 conforming to IEC 62061 Category 4 conforming to EN/ISO 13849-1 PL = e conforming to EN/ISO 13849-1
Optical characteristic	Resistance to light disturbance conforming to EN/IEC 61496-2
Mission time	20 year(s)
Safety reliability data	PFHd = 6.89E-9 1/h conforming to IEC 61508
Ambient air temperature for operation	-30...55 °C 14...131 °F
Ambient air temperature for storage	-35...70 °C -13...158 °F
Relative humidity	0...95 % without condensation
IP degree of protection	IP65 IP67
Shock resistance	10 gn for 16 ms conforming to IEC 61496-1
Vibration resistance	0.35 +/- 0.05 mm (f= 10...55 Hz) conforming to IEC 61496-1

## Offer Sustainability

Sustainable offer status	Green Premium product
EU RoHS Directive	Pro-active compliance (Product out of EU RoHS legal scope) <a href="#">EU RoHS Declaration</a>
Toxic heavy metal free	Yes
Mercury free	Yes
RoHS exemption information	<a href="#">Yes</a>
Environmental Disclosure	<a href="#">Product Environmental Profile</a>
Circularity Profile	<a href="#">End of Life Information</a>

## Contractual warranty

---

Warranty	18 months
----------	-----------

---

Dimensions

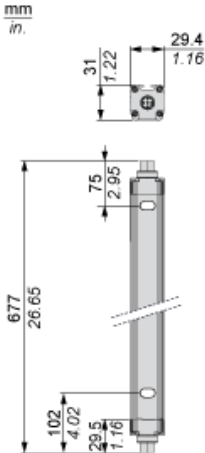

Brackets Dimensions

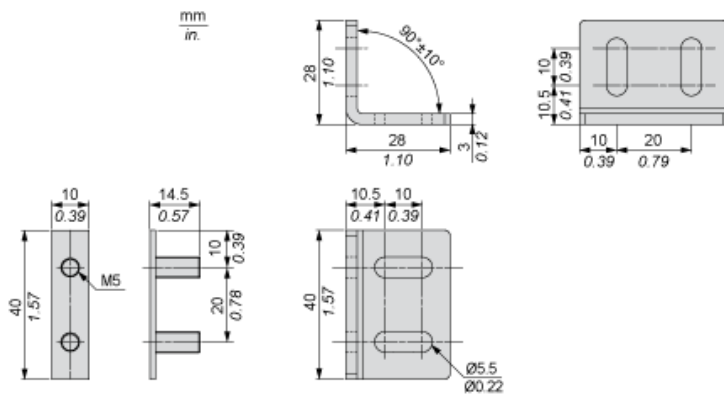

Mounting and Clearance



- (1) Insert
- (2) Bracket
- (3) Washer
- (4) Spring washer
- (5) Nut

---

## Wiring Diagrams

---

### Transmitter Connections

Slave primary connector at the bottom

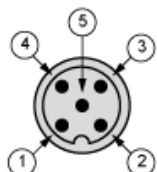

- (1) +24 Vdc
- (2) Master/Slave\_A
- (3) 0 Vdc
- (4) Master/Slave\_B
- (5) FE

Slave secondary connector at the top

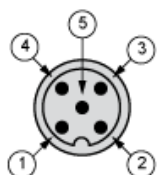

- (1) +24 Vdc
- (2) Master/Slave\_A
- (3) 0 Vdc
- (4) Master/Slave\_B
- (5) FE

### Receiver Connections

Slave primary connector at the bottom

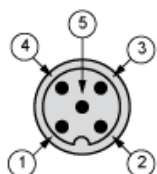

- (1) +24 Vdc
- (2) Master/Slave\_A
- (3) 0 Vdc
- (4) Master/Slave\_B
- (5) FE

Slave secondary connector at the top

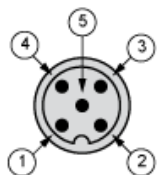

- (1) +24 Vdc
- (2) Master/Slave\_A
- (3) 0 Vdc
- (4) Master/Slave\_B
- (5) FE