



Main

Range of product	Preventa Safety detection
Accessory / separate part category	Mounting and fixing accessories
Accessory / separate part type	Curved fixing bracket
Product compatibility	XUSL2E XUSL4E
Accessory / separate part destination	Safety light curtain type 2 Safety light curtain type 4

Complementary

Kit composition	4 curved bracket(s)
Product weight	0.2 kg

Offer Sustainability

Sustainable offer status	Green Premium product
RoHS (date code: YYWW)	Compliant - since 1425 - Schneider Electric declaration of conformity
REACH	Reference not containing SVHC above the threshold
Product environmental profile	Available Download Product Environmental
Product end of life instructions	Available Download End Of Life Manual

The information provided in this documentation contains general descriptions and/or technical characteristics of the performance of the products contained herein. This documentation is not intended as a substitute for and is not to be used for determining suitability or reliability of these products for specific user applications. It is the duty of any such user or integrator to perform the appropriate and complete risk analysis, evaluation and testing of the products with respect to the relevant specific application or use thereof. Neither Schneider Electric Industries SAS nor any of its affiliates or subsidiaries shall be responsible or liable for misuse of the information contained herein.

Dimensions

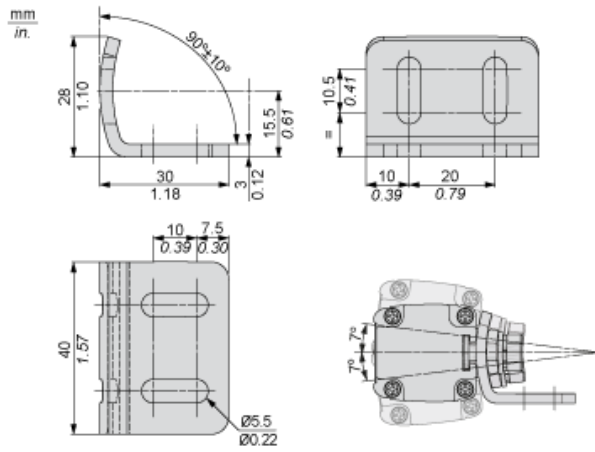

Mounting and Clearance

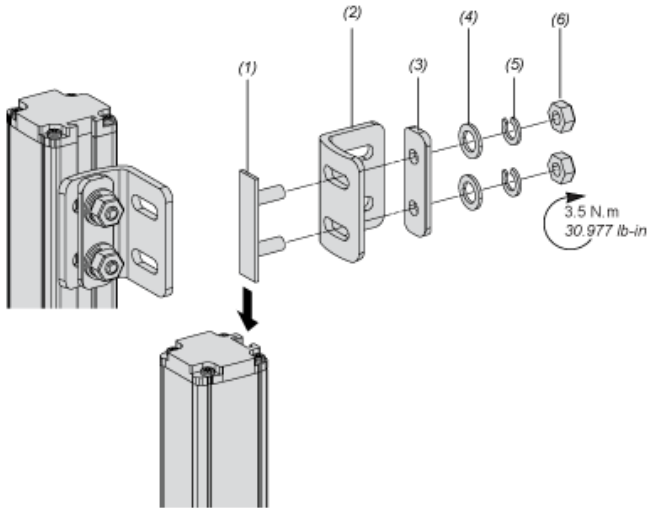

- (1) Insert
- (2) Curve bracket
- (3) Plate
- (4) Washer
- (5) Spring washer
- (6) Nut