

Price\* : 352.38 GBP



### Main

Range of product	OsiSense XU
Series name	Application material handling
Electronic sensor type	Photo-electric sensor
Sensor name	XUY
Sensor design	Frame
Detection system	Thru beam
Emission	Infrared
Way dimensions of optical frame	200 x 180 mm
Material	Metal
Supply circuit type	DC
Wiring technique	4-wire
Discrete output type	PNP or NPN
Discrete output function	1 NO or 1 NC programmable
Electrical connection	1 male connector M12, 4 pins
Product specific application	Dynamic detection of passage of objects Static detection of passage of objects
Minimum object diameter for detection	Dynamic mode: 10 mm (0.1...70 m/s) Static mode: 15 mm

### Complementary

Enclosure material	Painted aluminium
Lens material	Altuglass
Type of output signal	Discrete
Output type	Solid state
Status LED	Alarm: 1 LED (red) Output state: 1 LED (amber)
[Us] rated supply voltage	24 V DC with reverse polarity protection
Supply voltage limits	18...30 V DC
Switching capacity in mA	<= 100 mA (overload and short-circuit protection)
Switching frequency	> 5000 Hz
Maximum voltage drop	<2 V (closed state)

Current consumption	<= 150 mA no-load
Time delay range	0...5 s off-delay delay
Maximum delay first up	100 ms
Maximum delay recovery	0.1 ms
Setting-up	Sensitivity adjustment with potentiometer
Depth	25 mm
Height	230 mm
Width	265 mm
Product weight	1.2 kg

## Environment

Product certifications	CE CULus
Ambient air temperature for operation	0...60 °C
Ambient air temperature for storage	-20...80 °C
Immunity to ambient light	3000 lux incandescent bulb 10000 lux natural light
Vibration resistance	25 gn, amplitude = +/- 2 mm (f = 10...55 Hz) conforming to IEC 60068-2-6
Shock resistance	30 gn (duration = 11 ms) conforming to IEC 60068-2-27
IP degree of protection	IP65 conforming to IEC 60529

## Offer Sustainability

EU RoHS Directive	Pro-active compliance (Product out of EU RoHS legal scope) <a href="#">EU RoHS Declaration</a>
Mercury free	Yes
RoHS exemption information	<a href="#">Yes</a>

## Contractual warranty

Warranty	18 months
----------	-----------

Dimensions

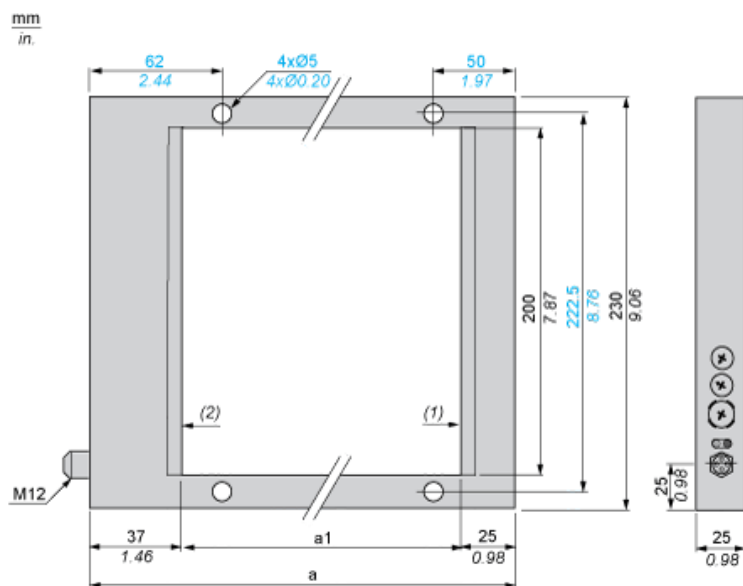

- (1) Transmitting face
- (2) Reception face

Dimensions in mm

a	a1
242	180

Dimensions in in.

a	a1
9.53	7.09

## Wiring Schemes (4-Wire DC)

### PNP Output

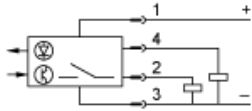

### NPN Output

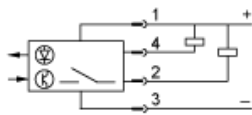

### Connector Scheme

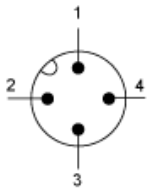

- 1: +
- 2: Not connected
- 3: -
- 4: Output