

Main

Accessory / separate part category	Cabling accessory
Accessory / separate part type	Jumper cable

Complementary

Jumper cable end 1	M12 male, :3 pins (straight), fixing: screw-on
Jumper cable end 2	Ø 8 mm female, :3 pins (elbowed), fixing: clip-on
Cable composition	3 x 0.34 mm ²
Cable length	1 m
Wire insulation material	PUR
Cable outer diameter	5.2 mm
[Ue] rated operational voltage	75 V DC 60 V AC
[In] rated current	4 A
Insulation resistance	>= 1000 MOhm
Resistance across terminals	<= 5000 mOhm
Product weight	0.05 kg

Environment

IP degree of protection	IP67
Ambient air temperature for operation	-5...90 °C (flexing) -35...90 °C (static)
Ambient air temperature for storage	-35...100 °C

Offer Sustainability

Sustainable offer status	Green Premium product
RoHS (date code: YYWW)	Compliant - since 0649 - Schneider Electric declaration of conformity
REACH	Reference not containing SVHC above the threshold
Product environmental profile	Available Download Product Environmental
Product end of life instructions	Available Download End Of Life Manual

The information provided in this documentation contains general descriptions and/or technical characteristics of the performance of the products contained herein. This documentation is not intended as a substitute for and is not to be used for determining suitability or reliability of these products for specific user applications. It is the duty of any such user or integrator to perform the appropriate and complete risk analysis, evaluation and testing of the products with respect to the relevant specific application or use thereof. Neither Schneider Electric Industries SAS nor any of its affiliates or subsidiaries shall be responsible or liable for misuse of the information contained herein.

Dimensions

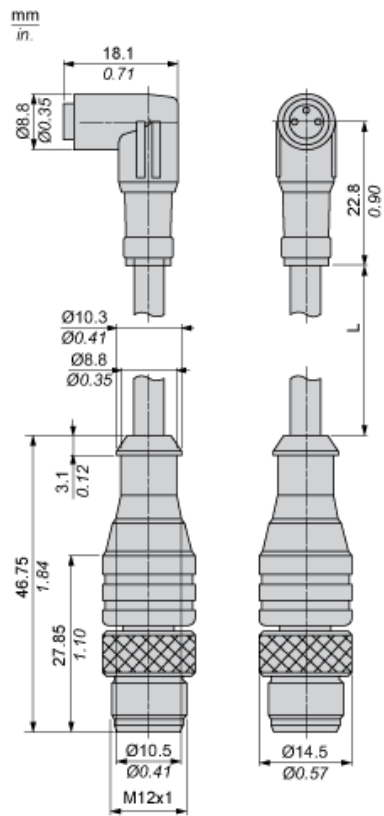

L : Length of cable

Connections and Schemes

